



PACKAGING BREAKDOWN
FOR MODEL 2006FD
RESIN FAN DECK w/ STEP~LADDERS & GATE

<u>CARTON</u>	<u>CONTENTS</u>	<u>WEIGHT</u>	<u>DIMENSIONS</u>
# 1	DECK PLATFORMS & SUPPORT FRAMES (3) (STEEL SUPPORT STRUCTURE PREATTACHED)	190 LBS	60 x 60 x 12
# 2	IN-POOL STEP~LADDER (1)	35 LBS	20 x 10³/₄ x 47¹/₂
# 3	RAILING PICKETS (36 PCS) RAILING HANDRAILS WITH INSERTS (5) SUPPORT BRACES (15) HANDRAIL CONNECTORS (10) HARDWARE KIT WITH INSTRUCTION (1) SUPPORT POST CAP (8) SUPPORT POSTS WITH INDERTS (8)	155 LBS	17¹/₂ x 14 x 96¹/₂
# 4	GROUND TO DECK STEP~LADDER (1)	35 LBS	20 x 10³/₄ x 47¹/₂
# 5	GATE FOR GROUND TO DECK (1)	10 LBS	20 x 6¹/₂ x 48¹/₂

NOTES:

- Each of the above five (5) boxes / cartons is individually packaged. All boxes are required for one complete Resin Fan Deck with Step-Ladders & Gate. Boxes are identified and labeled as "MODEL 2006FD – Box 1 of 5, 2 of 5, 3 of 5, etc. Total weight for each 5ft x 5ft deck = 425 lbs.



MODEL 2006FD 5ft x 13.5ft Resin Pool Fan Deck with Step~Ladders **FEATURES & SPECIFICATIONS**

- VINYL WORKS CANADA manufactures this Deck System to meet or exceed NSPI/BOCA/ANSI requirements for decks, entry systems, in-pool steps, ladders and ladder enclosures
- The Model 2006FD Deck System is manufactured using maintenance free, UV protected resins to maintain strength & color. A powder coated steel frame & bracing system provide strength and protection to the elements. Stainless hardware is used for years of worry free use. Resin components include the deck platform, support posts, railing systems and both step~ladders
- The deck surface measures 60" deep x 164" (across back face) & is designed to fit pools 48" to 54" in height. The deck with fit round pools 18ft to 33ft & oval pools with radius ends of 18ft or greater
- The deck is designed for 1400 lb load capacity (four persons max)
- A comfortable, anti-skid deck surface provides safety from slipping. The tread surfaces of both steps also have anti-skid surfaces
- A cantilever deck design eliminates gaps between the deck and pool top rail. This design protects the top rail of the pool. The deck & steps are self-supporting and do not attach to the pool structure
- Deck handrails measure 36" in height from deck surface to top of handrail. Internal steel channel is used for greater strength within the top rail. Pickets measure 7/8" x 1.5" in shape with an opening of 3.625" between pickets
- The Model 2006FD includes both the in-pool step (part # 2006IN) & the ground to deck step with gate (part #'s 2006G2D & 2006GP). The gate is self-closing, self-latching & lockable. The exterior position of the entry is entirely enclosed for protection when the pool is not in use
- The step systems utilize double handrails for both the inpool and exterior portions for greater safety and ease of entering & exiting the pool. Clearance between handrails is 16.5"
- All step treads measure 7.5" x 16.5". This makes the step systems very easy to climb when entering and exiting the pool
- Minimum obstruction of swimming space ~ in-pool step unit occupies only 22" within the pool (ideal for smaller pools)
- The in-pool step system is designed to prevent entrapment while allowing great circulation of the pool water (both through the side frames and through the tread risers)
- All tread risers and deck platform surfaces are embossed with no diving and no jumping signs for safety reminder. As well, the entry contains all required safety signage (embossed directly into the gate at entry). There is **ABSOLUTELY NO DIVING & NO JUMPING** into the pool ~ you could be seriously injured
- The Model 2006FD Deck System can be used with our Pool Fence systems to totally enclose and secure your pool. Both our 24" and 36" fencing will connect to deck by using our CNK24 Connector Kit (sold separately)
- Each unit includes explicit installation instructions and all necessary hardware for proper assembly. Vinyl Works Canada's toll free customer service number is printed on all instruction sheets should any customer need assistance
- VINYL WORKS CANADA reserves the right to change or alter the manufacturing specifications within the specified code restrictions. If there should be any questions regarding this or any of our other products please do not hesitate to contact our customer service at toll free 1-877-VINYL WK

REMEMBER, NOTHING REPLACES PARENTAL SUPERVISION ~ SWIM SAFELY !

IMPORTANT INSTRUCTIONS: Read all instructions carefully & completely to become familiar with parts, assembly, safety and proper use of this product. Failure to follow these instructions may result in serious personal injury.

TOOLS REQUIRED: sockets, wrench or nut driver, measuring tape, square, phillips (star) screwdriver, drill & 1/8" drill bit, pencil, level & hand saw + seven (7) 16" x 2" concrete blocks



SAFETY INSTRUCTIONS & PROPER USE

- This resin pool deck & step~ladder system has a 1400 lb load capacity - five persons max - when properly installed
- Step~Ladder entries have a 300 lb load capacity - one person
- The entry systems are designed & intended for use with the resin pool decks - Models 2006SD or 2006FD only
- Your above ground pool has shallow water - absolutely **NO DIVING** or **NO JUMPING** from deck into pool
- This product conforms to the latest revisions of the ANSI/NSPI-4 standards for above ground pool decks & entry systems
- For entry to & exit from the pool & deck, face step~ladder at all times
- Be aware - chairs or lounges with sharp or pointed legs may damage deck surface
- The ground to deck entry **MUST** be used with the gate installed & fully functional. Ensure the gate is locked when the pool is not in use - **AT ALL TIMES**
- Locate the ground to deck entry system on a solid base for greater stability & away from high traffic areas
- Secure both entry systems to deck for stability and safety
- Keep handrails and treads of both entry systems free from obstructions to avoid possible injury. Do not secure any items to the entry system. Such objects may create a potential for tripping
- **NEVER ALLOW CHILDREN TO SWIM UNATTENDED** - Nothing replaces parental supervision
- Assemble & install this deck & entry system as per the manufacturer's instructions. Do not deviate from these instructions - **ALWAYS SWIM SAFELY - NO DIVING** or **NO JUMPING** into the pool - you could be seriously injured

ASSEMBLY & INSTALLATION - IDENTIFY PARTS & COMPONENTS & HARDWARE



Deck Platforms & Frames (pre-attached - two square & one wedge)



Deck Fill Caps (13 pc) Post Caps (7 pc) Post Spacer (7pc)

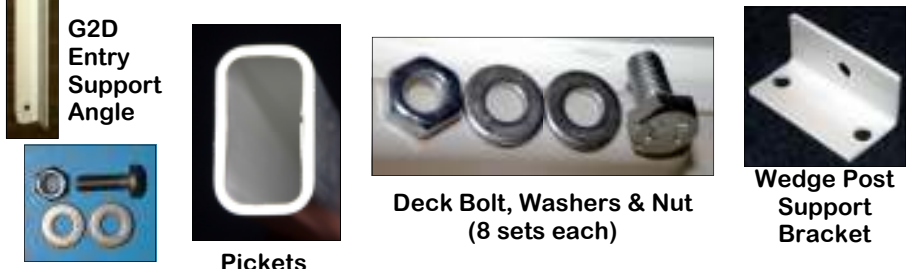

G2D Entry Support Angle

Pickets (36 pc)

Deck Bolt, Washers & Nut (8 sets each)

Wedge Post Support Bracket



Angle Bolts



Post Bolt + Washers & Nut (8 sets)



Screws (4 different sizes)



In-Pool Step Base Plate Bolts

THE MODEL 2006FD 5x13.5 RESIN DECK COMES PACKAGED IN FIVE (5) CARTONS

Make certain to familiarize yourself with all parts before starting assembly of your entry system. If you notice any parts damaged or missing, please contact our customer service staff for assistance
877-VINYL WK



In-Pool Step Base Plate (2 pc)



Posts (6 Long + 1 Medium + 1 Short)



Post Braces (15 pc)



Handrails (5 Pc - 2 L + 1 M + 1 S + 1 Angled)



Brace Bolts & Washers (11 pc each)



Handrail Connector Straight (8 pc +)



G2D Connectors (2 pc)



Handrail Connector Angled (2 pc +)

Step 1 - Organize & Get Ready for Assembly

Your pool deck is packaged in five cartons total. Familiarize yourself with components (see parts layout on page 1). Open the hardware kit & group the similar fasteners together (see 1.1 & 1.2 for screw identification & usage).

Measurement Guide

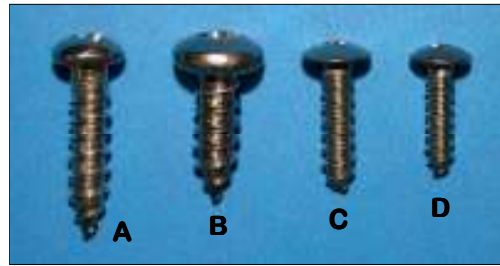
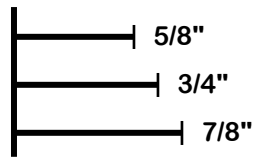

1.1



- A - #14 x 7/8" (15 pcs) for securing braces to support posts (see Step 5, 6 & 10)
- B - #14 x 3/4" (3 pcs) for securing the G2D top platform to entry support angle (see 2006G2D - Box 4 of 5)
- C - #8 x 3/4" (40 pcs) for securing handrail connectors to support posts (see Step 11)
- D - #6 x 5/8" (28 pcs) for securing handrails to handrail connectors (see Step 11)
- E - 1/4 x 3/4" (3 pcs) for securing G2D entry support angle to steel frame of deck platform (see Step 12)

1.2

Step 2 - Understand Position & Fit of Deck Platforms

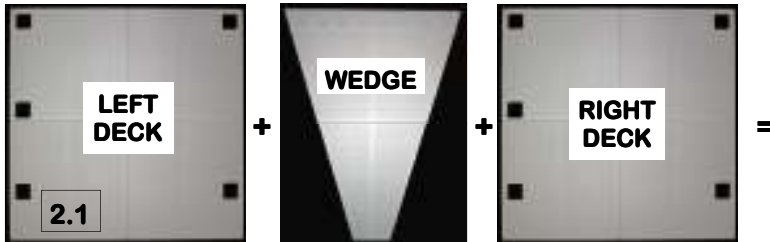

TOP VIEW

Identify the three different deck platforms (left, right & wedge - see 2.1). The platforms are designed & manufactured to fit together to make one large deck surface (see 2.2). Please familiarize yourself with the three components as it is important for a proper assembly & installation. Pins & holes on the edges of the platforms provide for a proper fit & alignment of the entire deck (see 2.3 & 2.5 & 2.6). The left & right deck platforms have holes & the wedge has pins. Only one face of the left & right deck platforms has holes to accept the pins (see 2.3 & 2.4). Identify these sides/faces and make certain to position accordingly. To begin, you will sub-assemble the left & right deck platforms & then join to the wedge to form the complete deck

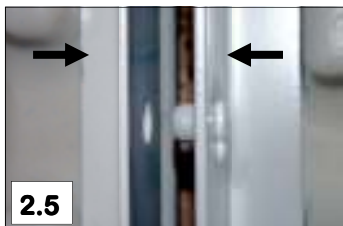

2.5



2.6

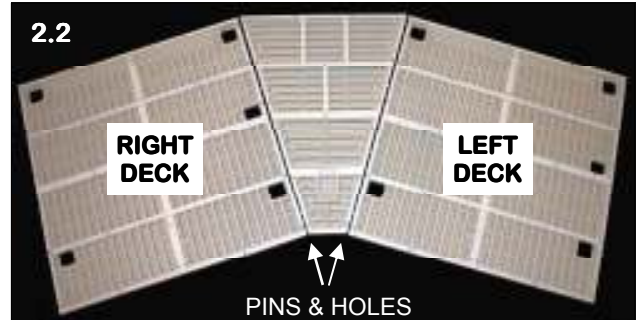

2.2

BOTTOM VIEW

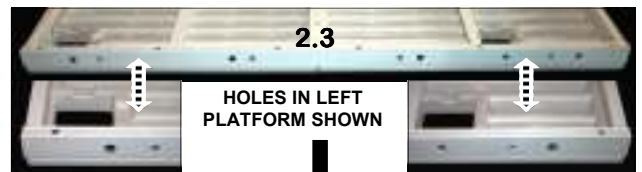

2.3

HOLES IN LEFT PLATFORM SHOWN

HOLES TO ACCEPT PINS

ON THESE INSIDE FACES

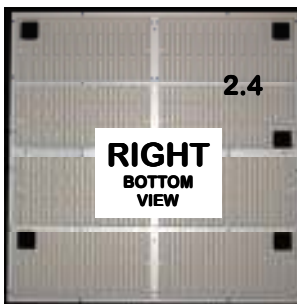

2.4

RIGHT
BOTTOM
VIEW

FRONT OF DECK-TOWARDS POOL

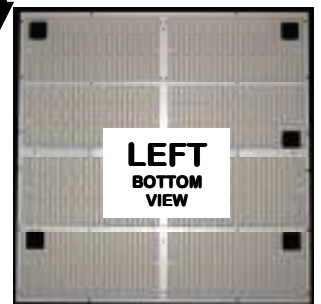

LEFT
BOTTOM
VIEW

FRONT OF DECK-TOWARDS POOL

Step 3 - Attach Brace Supports

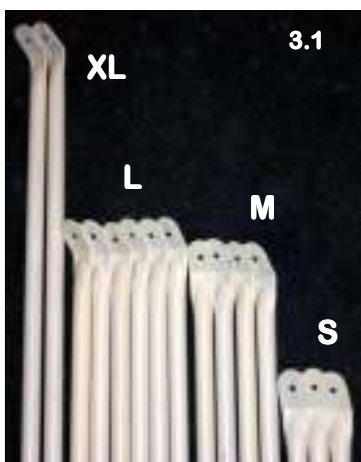

3.1

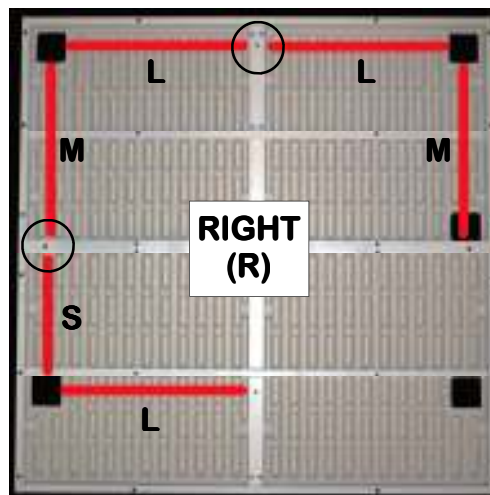

RIGHT
(R)

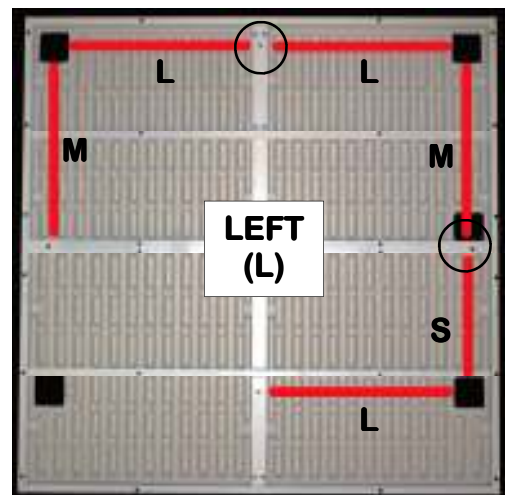

LEFT
(L)

BOTTOM VIEW - 3.3

(NOTE: L & R REVERSED BECAUSE VIEWING BOTTOM)



3.2



3.5



3.4



3.6

← ○ → CIRCLE = DOUBLE CONNECTION

Identify & sort braces by length. There are two extra long (XL), six long (L), four medium (M) and three short (S) braces (see 3.1). Identify & separate the 3/8" round x 3/4" long bolts & 3/8" small washers from hardware kit (see 3.2). Lay left & right deck platforms face down, side by side as shown & position braces (see 3.3). Note: three braces for wedge post do not get attached until Step 9. At four locations (noted by circles) two braces are secured using a single bolt & washer (see 3.4). Fit bolt (+ washer) through the large hole in end of braces and into threaded plate on steel frame (see 3.4 & 3.5 & 3.6) Tighten hardware to snug only. Complete both left & right deck accordingly

Step 4 - Position & Attach Long Support Posts

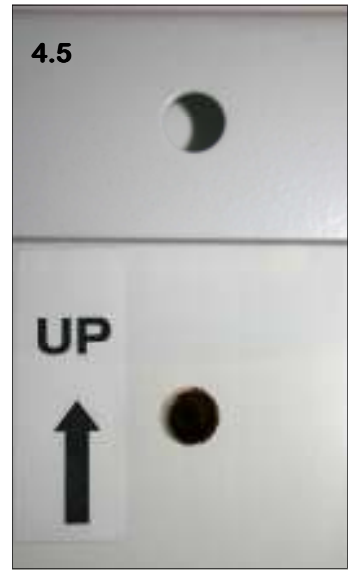
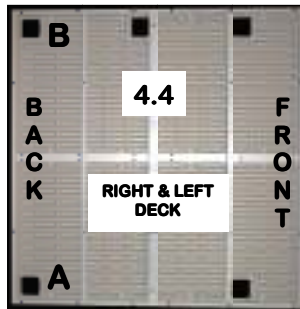
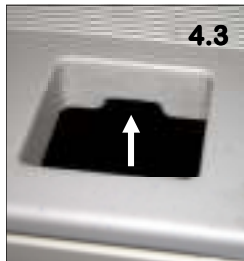
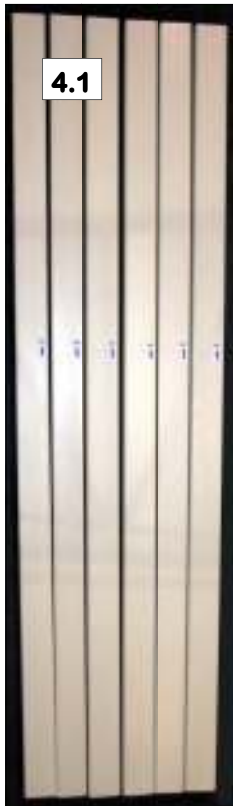

Select the six 96" long support posts (see 4.1). Note each post is marked with direction arrow (see 4.2). Stand deck platform with braces on it's edge so the back legs are towards the left (see 4.4). From bottom to top of platform, fit a support post through the post hole in platform (see 4.3 above). Start with the post towards the bottom (see 4.4 - post hole "A"). Make certain the direction arrow and hole in the post is facing the bolt hole in the platform frame (see 4.5). Position the post so the hole in the post is centered with the bolt hole in the frame (see 4.6). Using a post spacer (see 4.7) and a 3/8" x 5-3/4" bolt and washer (see 4.8), position spacer between post and frame and pass bolt through holes in frame, spacer & post (see 4.9). Secure only finger tight using washer & nut so post can move slightly (see 4.10). With deck still standing on edge, repeat above procedure for support post to be located at position "B" in 4.4 above. Repeat above for both LEFT & RIGHT deck platforms

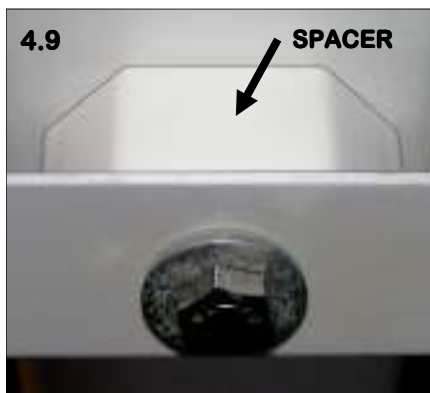
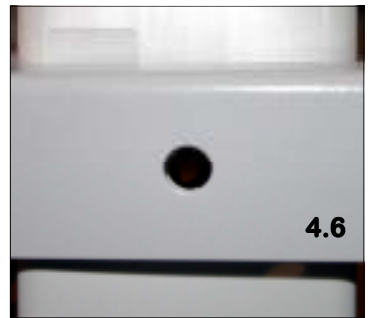

Step 5 - Secure Braces to Posts

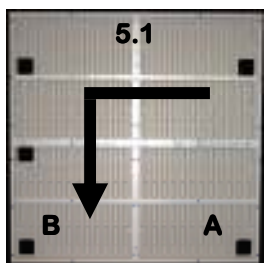
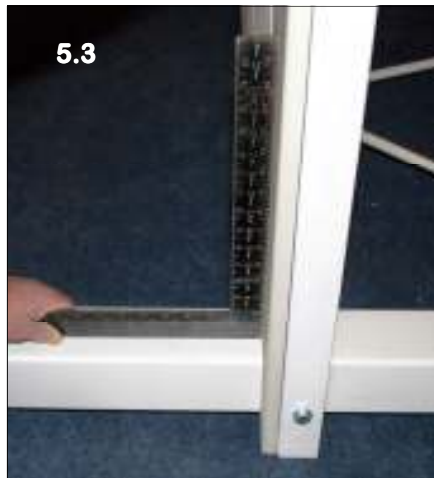

With each deck still on edge, gently rotate deck 90 degrees to the left, counter-clockwise (see 5.1). This way, first two posts will be towards ground and easy to work with. Starting with post in position B (see 5.1 & Step 4 above) use a square to be sure the post is plumb (square) to the deck platform surface (5.2 & 5.3). Holding post in place, drill a 1/8" pilot hole in center of post, through eye of brace (see 5.2 & 5.4). Secure using a #14 x 7/8" screw and 1/4" washer (see 5.5). Similarly, for the second brace, use square to make sure post is plumb in opposite direction (see 5.6) and drill pilot hole through eye of brace (see 5.7). Secure using a #14 x 7/8" screw & tiny washer as in 5.5. Repeat same procedure for support post in position A (see 5.1 & Step 4 above). Make certain all screws are tight into posts. Once braces securely in place, tighten post bolts (3/8" x 5-3/4" - from Step 4 - 4.9 & 4.10). Repeat for posts A & B for both LEFT & RIGHT deck platforms

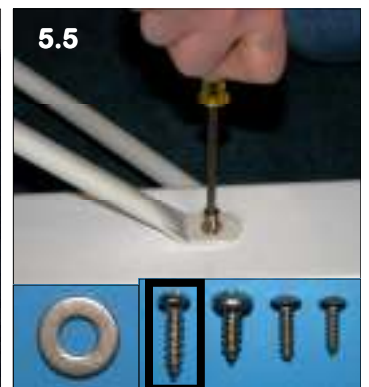
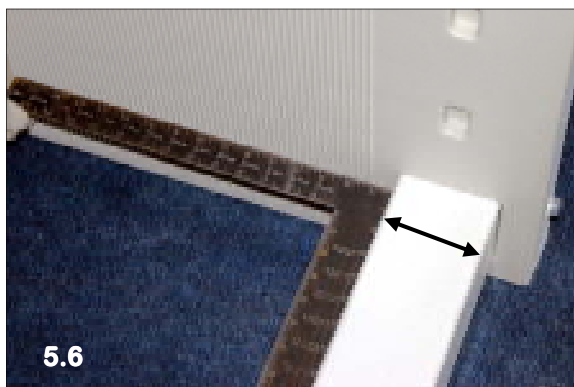

Step 6 - Position & Attach Remaining Long Posts & Braces in Both LEFT & RIGHT Deck Platforms

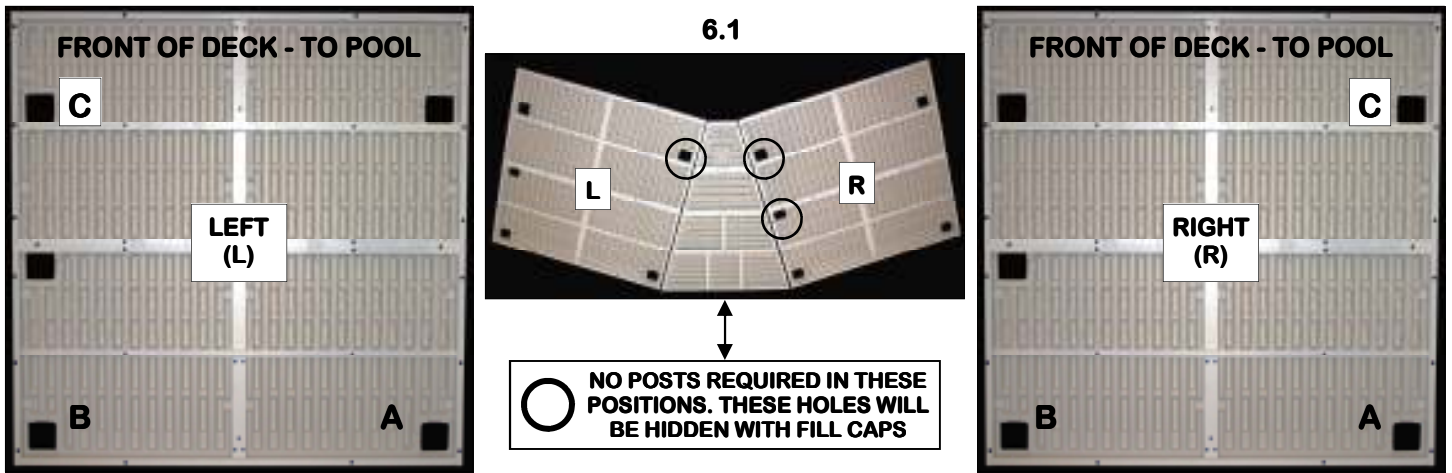

As outlined in Steps 4 & 5 previously, position, attach & secure two remaining long support posts & braces to LEFT & RIGHT deck platforms (see 6.1 for position C on both decks). Remember, make certain the hole and direction arrow on posts are facing bolt hole in the deck platform frame (see 6.2). From bottom to top of platform, fit remaining long posts through the post holes in platforms (see 6.3). Before attaching braces, make certain posts are plumb (square) to deck platform (see 6.4 & 6.5). Drill & secure braces as in Step 5 (see 6.5). When complete & in place, secure & tighten **ALL** hardware (brace screws & post bolts). With assistance, stand each deck on it's support posts, in the upright position & make certain they are balanced & do not tip over. Leaving sufficient space between LEFT & RIGHT deck platforms to fit wedge, position decks as shown in 6.1 above.



Step 7 - Attach & Secure Short Support Post

Select shortest post (see 7.1). Select post spacer (see 7.2) and a 3/8" x 5-3/4" bolt & washer (see 7.3). You will notice the shortest post has a bolt hole pre-drilled; it is to fit within the post hole in LEFT deck platform (see 7.4). Position and fit the post so the bolt hole is aligned with the bolt hole in the deck frame (see 7.5 & 7.6). Place spacer between post and deck frame and pass bolt, with washer, through the holes in deck frame, spacer and post (see 7.7). Plumb the post to the deck (see 6.4 above) and secure with washer & nut (see 7.8). Tighten hardware



Step 8 - Attach Remaining Post

Select remaining post & wedge post support bracket (see 8.1). The underside of wedge platform has a pocket to accept post and threaded holes to attach post support bracket (8.3). Using two 3/8" x 3/4" bolts & 3/8" small washers (8.2), secure support bracket in place (8.4 & 8.5). Tighten hardware. Align bolt hole in post with post support bracket and fit post in place with exposed inner support post fitting directly into wedge platform (see 8.6). Secure using a 3/8" x 5-3/4" bolt, washer both sides & nut (8.7). Tighten hardware to snug only so post can move slightly.

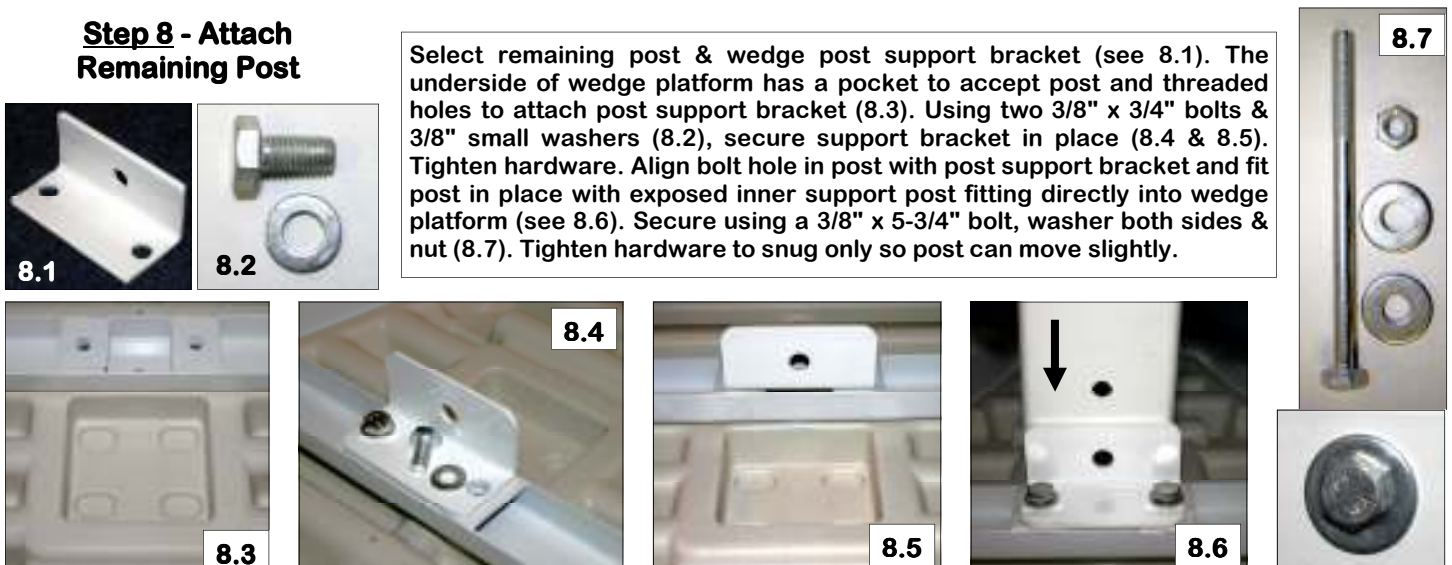

Step 9 - Fit & Secure Deck Platforms

9.1 RIGHT DECK LEFT DECK PINS & HOLES

9.2 **9.3** **9.5**

9.4 **9.6**

Fit wedge between partially assembled LEFT & RIGHT deck platforms (see 9.1). Make certain to align pins on wedge frame with holes on Left & Right deck frames (see 9.2 through 9.5). Fit deck platforms tightly together. Using eight 3/8" x 3/4" bolts, washers both sides of frames & nuts (see 9.6 - four per side - see 9.2 & 9.3) secure platforms together as one. Make certain hardware is tight

Step 10 - Attach Remaining Post Braces

10.1 XL S XL XL

10.2 XL L M S

10.3 **10.4** **10.5** **10.6** **10.7**

Select three remaining post braces (two XL & one S) used with the wedge post (see 10.2). Similar to Step 3 previously, attach & secure braces in the proper location (see 10.1) using the 3/8" x 3/4" bolts & washers (see 10.3 & 10.4). To secure the XL braces you will have to loosen the two bolts used for the front L braces (see 3.3 if required). With a level, make certain wedge post is plumb in both directions (see 10.5). Holding post in place, drill a 1/8" pilot hole in center of post, through hole of brace (see 10.6). Secure using #14 x 7/8" screw & 1/4" washer (see 10.7). Make sure hardware is tightened

Step 11

11.1 Attach Handrails

11.1 Attach Handrails

Gather parts for handrails (see 11.1 - handrails, pickets, connectors & covers, screws & post caps). There are four different handrails - small (S), medium (M), large (L) & angled (A). Note the difference between connectors: you have two angled (A) & eight straight. Angled are used for the angled handrail at the back of the wedge (see 11.1, 11.2 & 11.3). Also note positioning of handrails (see 11.2 & 11.3). Fit a handrail connector on both ends of all handrails (see 11.4). Angled connectors on ends of angled handrails. Make certain large, flat surface of connector is towards end of rail (see 11.4). Insert pickets, section by section (S-M-L-A), into molded pockets of deck surface (see 11.5). Fit tops of pickets into precut holes in appropriate handrails (see 11.2 & 11.6). Slide connectors to ends of rails, towards posts. Center connectors against posts and with pencil, mark holes in connectors on the posts (see 11.7). Once all connectors marked, push rail & connector out of the way and drill a pilot hole using a 1/8" bit at all pencil marks (see 11.8). Secure all connectors in place using #8 x 3/4" screws provided (see 11.9 & 11.10). Note difference in screw cover caps (straight & angled). Snap screw cover caps in place (see 11.10). To keep handrails from moving, drill a 1/8" hole through side of connector & handrail (see 11.11). Secure using #6 x 5/8" screws (see 11.1 & 11.12). Fit post caps and your railing is complete (see 11.12 & 11.13)

11.2 M L S L A

11.3 ANGLED STRAIGHT

11.4 ANGLED CONNECTOR & RAIL (SEE 11.3)

11.5 **11.6** **11.7** **11.8** **11.9** **11.10** **11.11** **11.12** **11.13**

Step 12 - Attach Entry Support Angle

Select three 1/4 x 3/4" bolts & #14 x 3/4 screws (see 12.1). Position the G2D entry support angle in place & align the three holes (see 12.2 & 12.3 & 12.4). Secure angle to deck frame using bolts, washers both sides & nuts. **TIGHTEN**. The angle will be used for the G2D assembly & installation (see 12.5 + accompanying instruction page for 2006G2D entry)

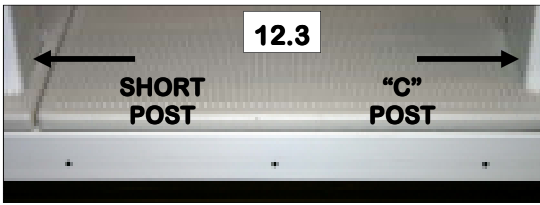
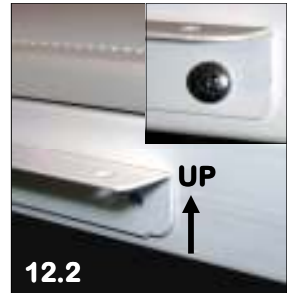

Step 13 - Position Deck Against Pool

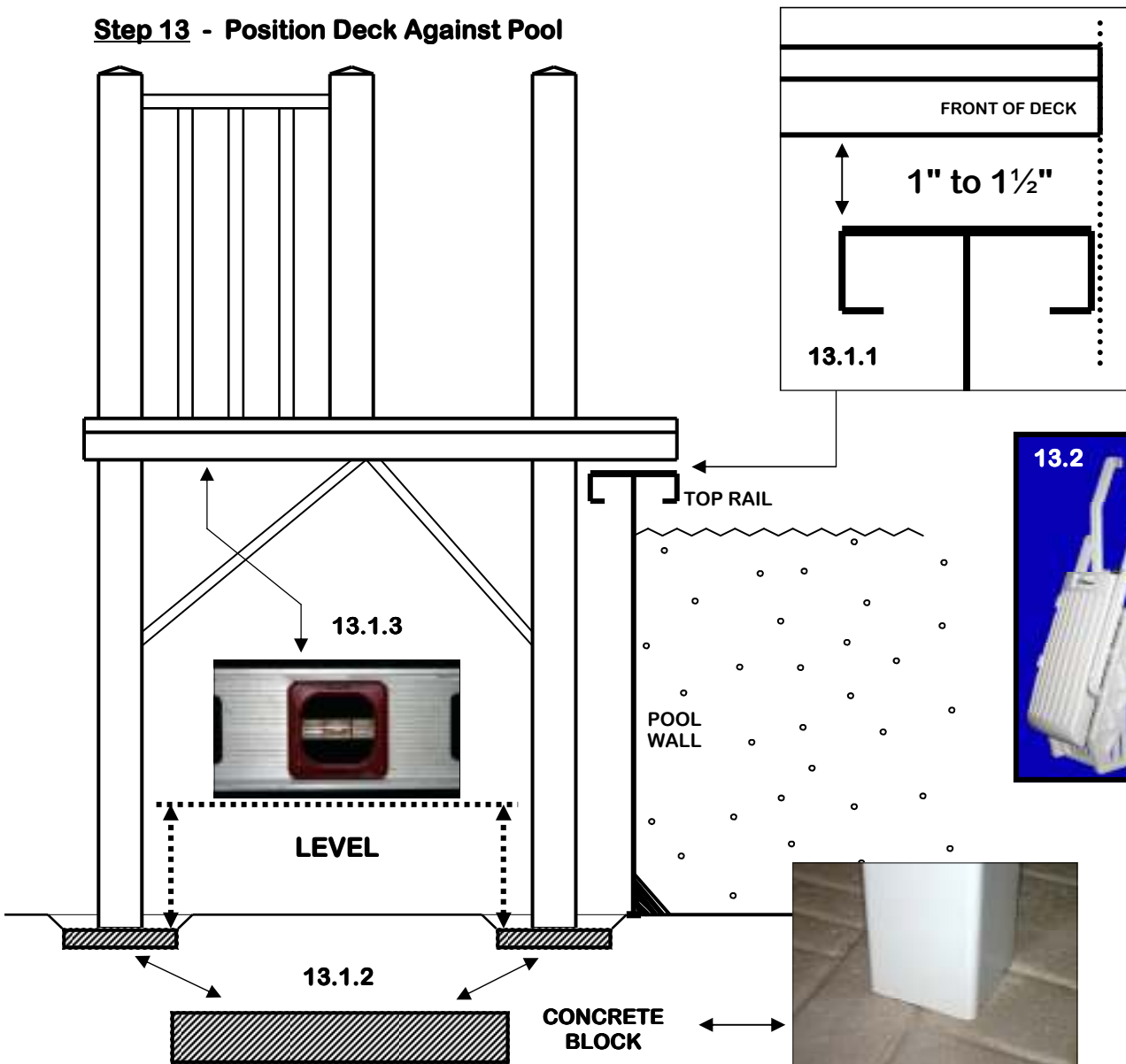

Position deck against pool at desired location. The front of the deck is designed to cantilever the top rail of the pool sufficient only to prevent stepping on top rail & to eliminate gap between deck & top rail (see 13.1.1 & 13.3). The front edge of the deck should not protrude past the inside face of the top rail. It is **IMPORTANT** to leave a 1" to 1½" gap between the top rail of the pool & the underside of the deck so the pool is not bearing the weight of the deck. Also, it allows space to install the winter cover. The seven support posts should sit on 16" square x 2" thick concrete blocks (see 13.1.2). These concrete footings must be leveled and set at the proper elevation (see 13.1.3) to maintain proper clearance between deck & pool. Set elevation of blocks rather than cutting posts. Once complete, make certain deck is level, stable & does not rock. Continue with assembly & installation of step-ladders (see 13.2). **ABSOLUTELY NO DIVING or JUMPING from deck into pool**

Want additional safety & security for your pool? Add a Vinyl Works Canada Resin Pool Fence Kit - available in either 24" or 36" heights (see 13.4 - inset - sold separately) Ask your retailer for more information





MODEL 2006IN IN-POOL STEP~LADDER



IMPORTANT INSTRUCTIONS: Read all instructions carefully & completely to become familiar with parts, assembly, safety and proper use of this product. Failure to follow these instructions may result in serious personal injury.

TOOLS REQUIRED: 7/16" socket or nut driver, measuring tape, Phillips (star) screwdriver (you may need a 5/16" drill bit & drill)

SAFETY INSTRUCTIONS & PROPER USE

- This pool step~ladder system has a 300 lb load capacity - one person - when proper installed
- This entry system is designed and intended for use with an above ground pool only - flat bottom pool
- Your above ground pool has shallow water - absolutely NO DIVING or NO JUMPING into the pool
- This product conform to the latest revisions of the ANSI/NSPI-4 recommended standards for above ground/on ground swimming pool ladders
- For entry & exit of the pool, face step~ladder at all times
- This system is designed for use by one person at all times
- Ensure the bottom of the side stringers are free of debris & any possible sharp edges as not to damage the pool liner. Use of a ladder or step pad (sold separately) is recommended for extra protection
- Locate entry system on a solid base within the pool
- Secure entry system to deck for stability and safety
- Keep handrails and treads free from obstructions to avoid possible injury. Do not secure any items to the entry system. Such objects (eg. thermometers, play toys, ropes) may create a potential for tripping or entrapment
- NEVER ALLOW CHILDREN TO SWIM UNATTENDED - Nothing replaces parental supervision
- Assemble and install this pool entry system as per the manufacturer's instructions. Do not deviate from these instructions - PLEASE ALWAYS SWIM SAFELY!

ASSEMBLY & INSTALLATION



Stringers - 1 Left & 1 Right



Tread-Riser - 3 pcs



Top Tread - 1 pc
Bottom Riser - 1 pc



Lower Handrails
1-Right & 1-Left



Upper Handrails
2-Right & 2-Left

Step 1 Identify Parts

MEASUREMENT GUIDE
FOR HARDWARE

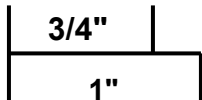

Rear Deck Flanges - 2



Front Deck Flanges - 2

Make certain to familiarize yourself with all parts before starting assembly of your entry system. If you notice any parts damaged or missing, please contact our customer service staff for assistance.

877-VINYL WK

Step 2 Fit Treads, Risers & Stringers



2.1



2.2



2.3



2.4



2.5

Lay stringer on flat surface with indentations to accept treads/risers facing up (as shown above in "Parts"). Fit single bottom riser, with warning signs facing forward, into bottom indentation (2.1) and snap into place making certain the button lock tab of the riser passes through hole in stringer. Fit top tread, with anti-skid surface facing upwards, into top indentation (2.2) and snap into place. Fold tread-riser and fit into indentations above single riser (2.3). Make certain when folding that the anti-skid surface is facing upwards (2.6). Repeat for remaining two tread-risers (2.4) making certain all button lock tabs protrude and lock in place (2.7). Place opposite stringer on top of tread-risers (2.5) aligning indentations in stringer and button lock tabs with holes in stringer. Snap stringer in place locking all tabs.

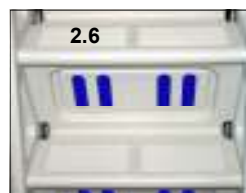

2.6



2.7

VINYL WORKS CANADA
P.O. Box 96 Port Colborne, Ontario, Canada L3K5V7

Step 3 - Add Weight to Stringers

This pool entry requires additional weight for ballast & to prevent the unit from floating. The top portion of the stringers are open, exposing the inside cavity (3.1 & 3.2). This cavity is sealed and is designed to hold material for weight. Put approximately ten pounds (10 lbs) of coarse sand or gravel into both the left & right stringer of the entry. This will give your fully assembled system the required stability within the pool water. Additional weight can be added if desired or if you find the system requires more weight for stability.

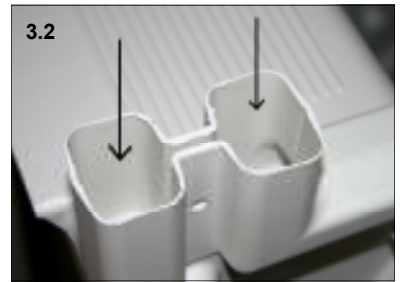

Step 4 - Attach Upper Handrails



Identify the upper RIGHT (R) & LEFT (L) handrails (small stamp in part - see 4.2 above). Fit handrail pair together as shown in 4.1, 4.2 and 4.3 above, align holes and secure using 1" bolts, washers both sides & nut. Tighten all hardware. Repeat for both sets of upper handrails. Slide front deck flanges over upper handrails before fitting handrails into place (see 4.4). Make certain front flanges face proper direction. Fit assembled handrail pairs into top opening of assembled entry as shown in 4.4 and 4.5. Make certain the correct handrail fits into the appropriate hole in the step assembly as it is import for the next step. Fit the ends of the upper handrails into the opening at the top of each stringer/tread set as shown in 4.4, 4.5 & 4.6 below. Align holes & secure using 3/4" bolt, double washer & nut. Repeat for both sides. Tighten all hardware.

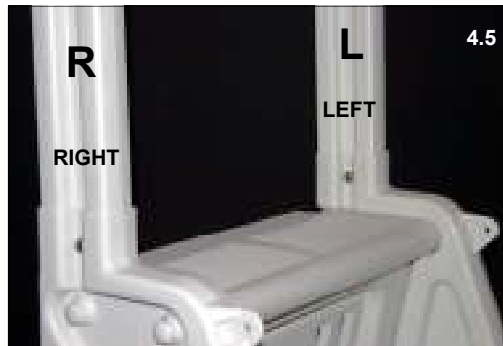
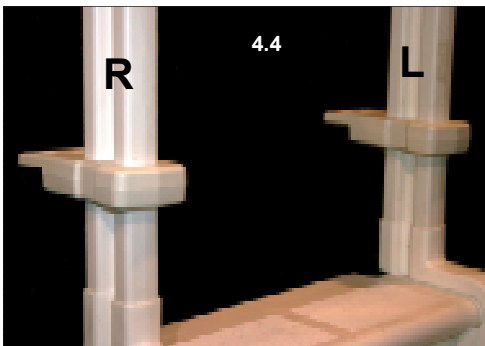

Step 5 Attach Lower Handrails

Identify & separate the RIGHT (R) & LEFT (L) lower handrails (see 5.1). Facing step system as to climb, align RIGHT (R) handrail to right side of step (see 5.2). Make certain handrail is on the inside of three tabs of stringer and inside of tab on upper handrail (see 5.3). When on the inside of tab on upper handrail, the upper & lower handrails will be perfectly in line (see 5.4). Align holes and fasten using a 3/4" bolt, double washer and nut at all four locations. Tighten hardware. Similarly, align left handrail on the inside of tabs on left side of stringer and upper handrail (see 5.5). Align holes and fasten using a 3/4" bolt, double washer and nut for all four locations. Tighten hardware.

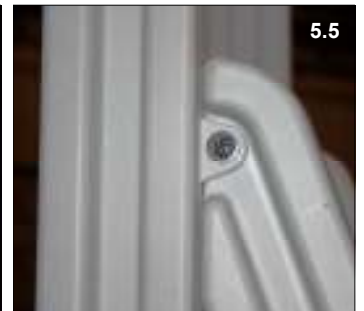
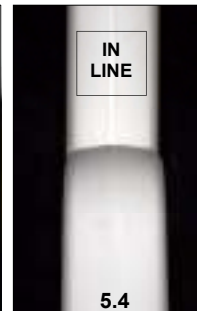

Step 6 - Place & Secure within Pool

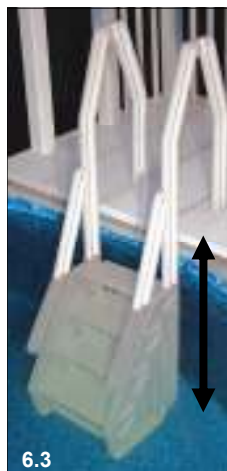
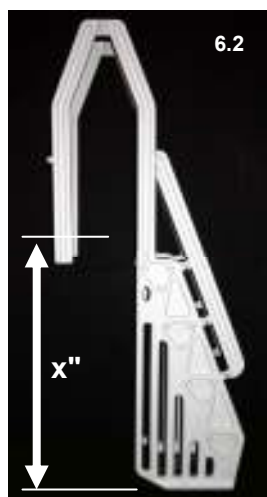
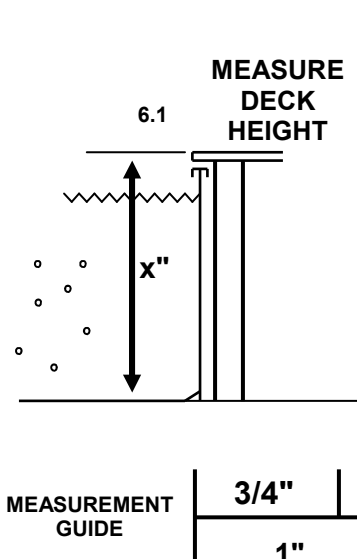

Measure depth of pool (inside pool) to the height of the pool deck (see 6.1 & 6.3). Transfer this measurement to the upper handrails to connect to deck surface (see 6.2). Cut excess upper handrails if required. Slide rear flanges (see 6.4) onto handrails and position step system into the pool. Make certain the step rests firmly on floor of pool & is pulled tight against the pool deck to minimize the gap between entry and pool wall (see 6.5). Secure all flanges to deck surface as outlined on following page (supplement for VWC Resin Decks).

Remove the in-pool step for winter storage. Swim safely and never leave children unattended.

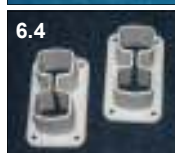

Step 1 - Identify Hardware & Parts Required or Used



1/4 x 3/4 bolts
washers & nuts



1/4 x 3 bolts
washers & nuts



#10 x 1 screws

MEASUREMENT
GUIDE

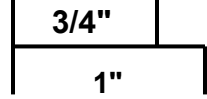

Rear flange base plates



1/4 drill bit
& drill



Rear flanges



Front flanges

Step 2 - Attach and Secure Front & Rear Flanges to Deck

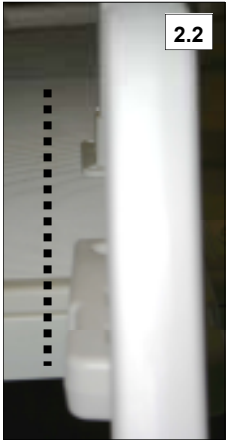

Continued from Step 6 of In-Pool instruction (previous page), make certain step in pulled tight against front face of deck and is resting on bottom of pool (see 2.1). Align front and rear flanges so they are in-line with one another (see 2.2) and both sets of upper handrails are perfectly parallel (distance equal between - front & back). With a pencil, mark the four fastener holes in the rear flange on the deck surface (see 2.3). Repeat for both rear flanges. Remove handrails from rear flanges and move assembled step aside. Using a 1/4 drill bit and holding rear flange in place on pencil marks, drill through rear flange and deck platform (see 2.4). **MAKE SURE THE FOUR PENCIL MARKS ALIGN AS NOT TO DRILL IN INCORRECT LOCATION.** Repeat for both rear flanges. The rear flange base plates are designed to align with the four bolt holes of the flange (see 2.5). Fit four 3 inch bolts through flange, deck platform and base plate on underside of deck platform (see 2.6 & 2.7). Secure bolts using a washer and nut. Repeat for both rear flanges. **DO NOT OVERTIGHTEN HARDWARE.** Reposition step and fit handrails into both rear flanges. Pull step tight to front face of deck and realign front and rear flanges (as in 2.2). Secure front flanges using #10 x 1 inch screws - **DO NOT OVERTIGHTEN SCREWS** (see 2.8). Drill center of rear flanges using 1/4 drill bit and secure with 3/4 bolts, washers both sides and nuts (see 2.9 & 2.10). Tighten this hardware connection. Check for stability before use

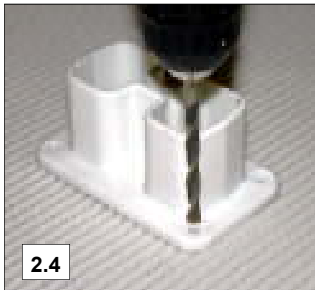

NEVER ALLOW CHILDREN TO SWIM UNATTENDED - SWIM SAFELY - NO DIVING or JUMPING INTO POOL



IMPORTANT INSTRUCTIONS: Read all instructions carefully & completely to become familiar with parts, assembly, safety and proper use of this product. Failure to follow these instructions may result in serious personal injury.

TOOLS REQUIRED: 7/16" socket, wrench or nut driver, measuring tape, Phillips (star) screwdriver, drill & 1/8" & 1/4" drill bits

SAFETY INSTRUCTIONS & PROPER USE

- This pool step~ladder system has a 300 lb load capacity - one person - when properly installed
- This entry system is designed & intended for use with our resin pool decks - Models 2006SD or 2006FD
- Your above ground pool has shallow water - absolutely **NO DIVING** or **NO JUMPING** from deck into pool
- This product conform to the latest revisions of the ANSI/NSPI-4 recommended standards for above ground on ground swimming pool ladders / entry systems
- For entry & exit of the pool & deck, face step~ladder at all times
- This system is designed for use by one person at all times
- The entry **MUST** be used with the gate (boxed separately) fully functional. Ensure the gate is locked when the pool is not in use
- Locate entry system on a solid base for greater stability
- Secure entry system to deck for stability and safety
- Keep handrails and treads free from obstructions to avoid possible injury. Do not secure any items to the entry system. Such objects may create a potential for tripping
- **NEVER ALLOW CHILDREN TO SWIM UNATTENDED** - Nothing replaces parental supervision
- Assemble and install this deck entry system as per the manufacturer's instructions. Do not deviate from these instructions - **PLEASE ALWAYS SWIM SAFELY!**

ASSEMBLY & INSTALLATION



Stringers - 1 Left & 1 Right



Tread-Riser - 3 pcs



Top Tread - 1 pc
Bottom Riser - 1 pc



Lower Handrails
1-Right & 1-Left



Upper Handrails
1-Right & 1-Left



Half
Top
Platform
1 pc

Step 1

Identify Parts

Hardware
Measurement Guide

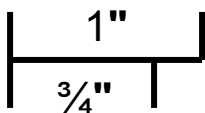

Hardware &
Instruction Included

This 2006G2D Ground to Deck entry is to be used with either the Model 2006SD - 5x5 Resin Deck or the Model 2006FD - 13.5x5 Resin Fan Deck. The gate for this entry (Model 2006GP) is packaged in a separate carton. **DO NOT** use entry without gate

Make certain to familiarize yourself with all parts before starting assembly of your entry system. If you notice any parts damaged or missing, please contact our customer service staff for assistance
877-VINYL WK

Step 2

Fit Treads, Risers & Stringers



Lay stringer on flat surface with indentations to accept treads/risers facing up (as shown above in "Parts"). Fit single bottom riser, with warning signs facing forward, into bottom indentation (2.1) and snap into place making certain the button lock tab of the riser passes through hole in stringer. Fit top tread, with anti-skid surface facing upwards, into top indentation (2.2) and snap into place. Fold tread-riser and fit into indentations above single riser (2.3). Make certain when folding that the anti-skid surface is facing upwards (2.6). Repeat for remaining two tread-risers (2.4) making certain all button lock tabs protrude and lock in place (2.7). Place opposite stringer on top of treads-risers (2.5) aligning indentations in stringer and button lock tabs with holes in stringer. Snap stringer in place locking all tabs.

Step 3 - Attach Upper Handrails & Platform

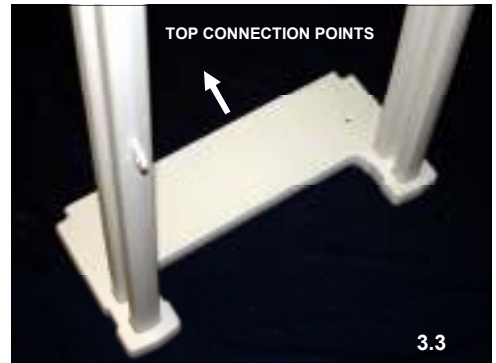
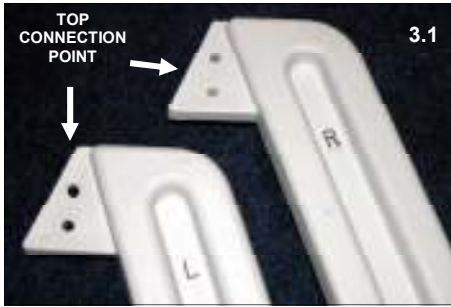

Identify the RIGHT (R) & LEFT (L) upper handrails as shown in 3.1. With the anti-skid surface of the half platform facing upward, fit the upper handrails through as shown in 3.2 & 3.3 above. Make certain the RIGHT & LEFT are placed in the appropriate holes as indicated. Also, make certain the top connection point is towards the straight edge of platform (See 3.1 & 3.3). Slide the platform up the handrails approximately 8". Fit the ends of the upper handrails into the step unit as indicated in 3.4. Make certain the handrails go all the way in, align bolt holes & secure using a 3/4" bolt, washer both sides and nut (see 3.5). Repeat for both the left & right handrails & tighten hardware.

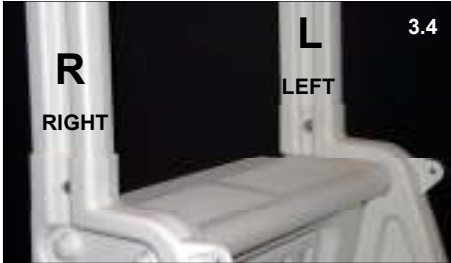

MEASUREMENT GUIDE FOR HARDWARE

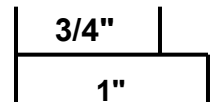

Step 4 Attach Lower Handrails

Identify & separate the RIGHT (R) & LEFT (L) lower handrails (see 4.1). Facing step system as to climb, align RIGHT (R) handrail to right side of step (see 4.2). Make certain handrail is on the inside of three tabs of stringer and inside of tab on upper handrail (see 4.3). When on the inside of tab on upper handrail, the upper & lower handrails will be perfectly in line (see 4.4). Align holes and fasten using a 3/4" bolt, washer both sides & nut at all four locations. Tighten hardware. Similarly, align left handrail on the inside of tabs of left stringer and upper handrail (see 4.5). Align holes and fasten using a 3/4" bolt, washer both sides & nut for all four locations. Tighten hardware. You will notice that the left handrail has holes in it (see 4.6) - these are used for attaching the gate to the step unit in a later procedure (see 6.5 below - 2006GP Gate Package).

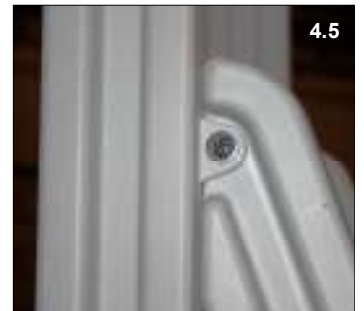

Step 5 - Position Entry, Level & Secure Top Platform

Position entry against deck at post opening (see 5.1). Level half platform (up & down) to match top surface of pool deck (see 5.2). With a pencil, mark pin location as outlined by black arrow in 5.2. Using a 1/4" drill bit, drill a hole through upper handrail and insert pin equidistant on both sides of handrail (see 5.3). Repeat for both handrails & pins. Snap & lock half platform in place by pushing down on platform (see LOCK in 5.2). Center the platform in deck opening (between posts) and make certain there is no gap between platform and deck (see 5.4). From the underside of the half platform, mark & drill 1/8" holes at three hole locations in platform support. Secure in place using three #14 x 1" screws provided with DECK hardware (see 5.4) Make certain hardware is tight but do not over tighten as it may strip hole for screws

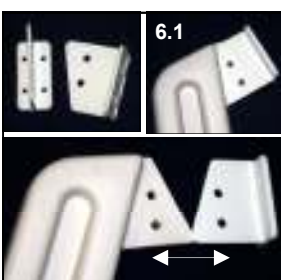
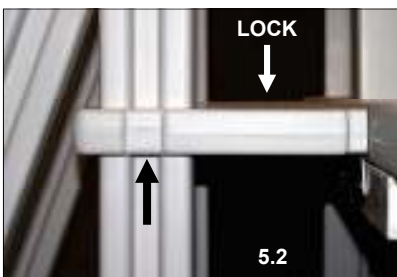

Step 6 - Secure Upper Handrails to Deck

Locate the handrail connector brackets packaged with the deck. Attach brackets to the **OUTSIDE** of both handrails using two 1" bolts, washer both sides & nuts as outlined in 6.1 & 6.2 (only finger tight as you may need to remove them). Position bracket at edge of deck post & mark hole locations (see 6.3). Predrill holes in deck post using 1/8" drill bit. Secure brackets & handrails to deck posts (see 6.4) using #6 x 5/8" screws packaged with deck hardware. Make certain all hardware is tight. When complete, go to **GATE PACKAGE (2006GP)**. See instructions & hardware packaged within. **DO NOT** use entry without gate installed & functioning properly (see 6.5). **GO TO 2006GP BOX - GATE PACKAGE**

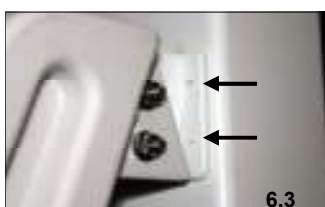

MODEL 2006GP - GATE PACKAGE

for MODEL 2006AF A-FRAME ENTRY
or MODEL 2006G2D GROUND TO DECK ENTRY



IMPORTANT INSTRUCTIONS: Read all instructions carefully & completely to become familiar with parts, assembly, safety and proper use of this product. Failure to follow these instructions may result in serious personal injury. **SWIM RESPONSIBLY & SAFELY!**

TOOLS REQUIRED: 7/16" socket - nut driver or wrench, Phillips (star) screwdriver, pencil, 1/8" drill bit & drill + a lock for security when the pool is not in use

SAFETY INSTRUCTIONS & PROPER USE - ASSEMBLY & INSTALLATION

- This pool step~ladder entry system has a 300 lb load capacity - one person - when properly installed
- This entry system is designed & intended for use with an above ground pool only - flat bottom pool
- Your above ground pool has shallow water - absolutely **NO DIVING** or **NO JUMPING** into the pool
- This product conform to the latest revisions of the ANSI/NSPI-4 recommended standards for above ground/on ground swimming pool ladders
- For entry & exit of the pool, face step~ladder at all times
- This system is designed for use by one person at all times
- This system is designed with a protecting gate system - **NEVER** use system without gate attached & fully functional. When pool is not in use, make certain gate is securely closed, latched & locked
- Locate entry system on a solid base and free from high traffic areas around the pool
- Secure entry system to top rail of pool for greater stability and safety
- Keep top platform and treads free from obstructions to avoid possible injury. Do not secure any items to the entry system. Such objects (eg. thermometers, play toys, ropes) may create a potential for tripping or entrapment
- **NEVER ALLOW CHILDREN TO SWIM UNATTENDED** - Nothing replaces parental supervision
- Install this gate for pool entry system as per the manufacturer's instructions. Do not deviate from these instructions

Step 1 Identify Parts

Hardware & Instructions Included



Gate Stop - 1 pc
Gate Hinges - 2 sets
(outer - larger)(inner - smaller)



Gate - 1 pc
(gate, hinges & stop packaged in box 2)

This gate + components is packaged in one carton and identified as BOX 2 of 2 for either the Model 2006AF or Model 2006G2D - please make certain you have all the proper cartons to complete your chosen entry system

Familiarize yourself with all parts before starting assembly of the entry system. If you notice any parts damaged or missing, contact our customer service for assistance (877-VINYL WK)



Step 2 Secure Hinge Sets & Stop In Place



The LEFT lower handrail on the exterior portion of the entry has holes to accept the hinges & gate stop (see 2.1). Begin by securing the gate stop in place. Fit the stop on the inside face of the handrail - it is form fitting (see 2.2). Secure using two 1/4 x 3/4" bolts, washers on inside & nuts. Tighten hardware. Fit a set of hinges in place around handrail as outlined in 2.3. The smaller hinge fits on the inside of handrail and the large on the outside. Using two 1/4 x 3/4 bolts, washers inside & nuts in the back two holes **ONLY**, secure **ONLY FINGER TIGHT**. Repeat for second set of hinges (see 2.4)

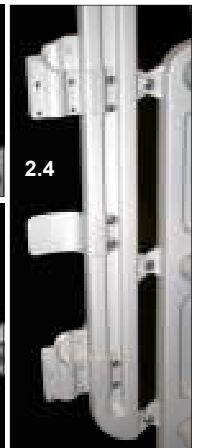
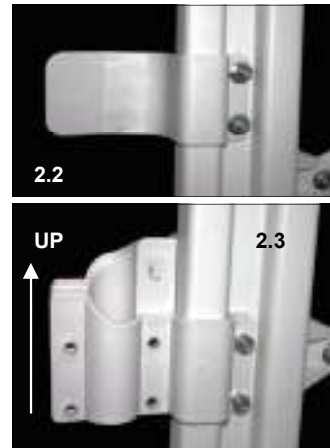

Step 3 - Fit & Secure Gate

Gently pry open gate hinge sets and fit gate into place as shown in 3.1 - both top & bottom. Secure gate hinge sets using the remaining 1/4 x 3/4" bolts, washers and nuts similar to Step 2 (see 3.2 & 3.3). Tighten all hardware & make certain gate opens and closes smoothly (see 3.4)



Step 4 - Attach Striker & Latch

Before attaching striker & latch, be sure gate is closed and pushed **DOWN** within hinge sets (see 3.3 above). Attach striker to gate (see 4.1). Striker is to be inside of gate, angled appropriately. Secure with 3/16 x 3/4" bolts, washers inside & nuts. Tighten hardware. With gate closed, down entirely, & striker in latch (see 4.2); position latch in the center of handrail and mark holes with pencil. Make certain striker is centered in latch correctly & latch is closed (see 4.2 & 4.3). Pre-drill 1/8" holes & secure using #8 x 3/4" screws (see 4.4). **DO NOT** over tighten screws as plastic may strip. Test gate to be sure it operates properly. Assembly is now complete (see 4.5 & 4.6). **LOCK GATE WHEN POOL IS NOT IN USE**



NOTHING REPLACES PARENTAL SUPERVISION