

STA-RITE®
'LIL SHARK™
AUTOMATIC POOL CLEANER

O W N E R ' S M A N U A L

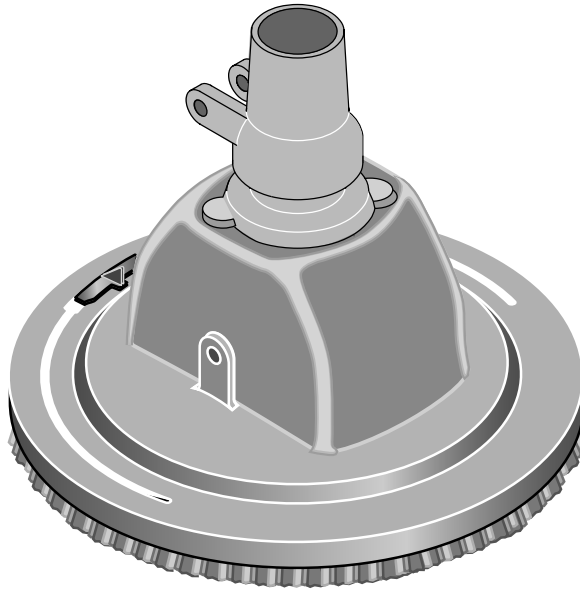

Model GW8000

OPERATION, TROUBLESHOOTING & PARTS

About Safety

- Before installing the cleaner, review and understand all warnings and safety information on inside cover of manual. Read and understand all installation information.

Sta-Rite Pool/Spa Group

293 Wright Street, Delavan, WI 53115

International: 262-728-5551, FAX: 262-728-7550

www.starite.com

Union City, TN • Delavan, WI • Mississauga, Ont. • Murrieta, CA

About your Pool and Filter System

Pre-Installation Check List:

- **Before installing the cleaner** in a vinyl liner pool, check liner closely for signs of deterioration or damage from age, chemicals, pool wall damage, etc. If any damage is found, have a qualified pool professional make all necessary repairs. **Also,**
- If there are any stones, roots, etc., under the liner, remove them **before** installing the cleaner.
- Before you install the cleaner, make sure you have cleaned the filter (including backwashing) and emptied all baskets.
- Always make sure hose and cleaner are full of water **before** starting pump. Running pump dry may cause overheating and damage pump.
- The cleaner is designed to maintain a clean pool. It was not designed for initial cleanup when opening pool for the season.

Safety Instructions

⚠ This is the safety alert symbol. When you see this symbol on your system or in this manual, look for one of the following signal words and be alert to the potential for personal injury.

⚠ DANGER warns about hazards that **will** cause death, serious personal injury, or major property damage if ignored.

⚠ WARNING warns about hazards that **can** cause death, serious personal injury, or major property damage if ignored.

⚠ CAUTION warns about hazards that **will** or **can** cause minor personal injury or property damage if ignored.

Carefully read and follow all safety instructions in this manual and on equipment. Keep safety labels in good condition; replace if missing or damaged.

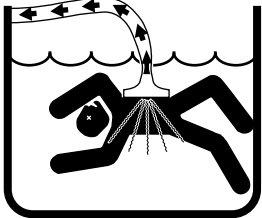
⚠ WARNING 	Hazardous suction. Can trap and tear hair or body parts. Can cause drowning. Do not play with cleaner or hose or apply to body. Do not let children use or play with pool cleaner. Stop pump before attempting to clean unit.
--	--

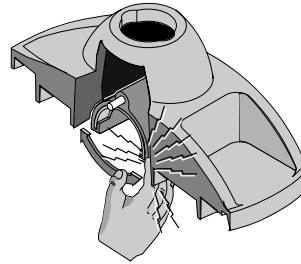

⚠ CAUTION Oscillator may injure hands or fingers. **Stop pump** before attempting to clean out pool cleaner head.

⚠ WARNING Hose can trip or entangle swimmers. Do not allow swimmers in pool while pool cleaner is operating.

About Maintenance and Care

⚠ WARNING Hazardous suction. **Stop pump** before attempting to clean pool cleaner.

- Keep skimmer basket and pump strainer basket clean and free of debris.
- If cleaner jams with large debris (leaves, sticks, etc.), try cleaning debris first from bottom of unit. If this doesn't clear unit, remove top swivel assembly (turn 1/4 turn) and clear the debris from the top.
- Remove the pool cleaner from the pool before super chlorinating (shocking) or chemical balancing. Wait at least four hours after the chemical procedure before reinstalling the cleaner.
- Make sure that the cleaner's brush bristles don't become deformed during storage. Store the unit so that it doesn't sit on the bristles and so that nothing compresses them.
- If possible, do not coil the hose. Store it flat and straight.
- If necessary to remove oscillator, see "Oscillator Removal", Page 7.

More About the Cleaner and Accessories:

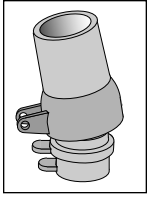

Swivel Assembly:

- Insert assembly into cleaner body and turn 1/4 turn clockwise.
- If you attach a unidapt handle to the swivel for manual vacuuming, be sure it is a special, floating unidapt handle (order No. GW9019; purchase locally). Use of a different unidapt handle will hinder the cleaner's performance.

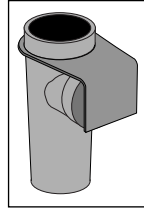

Automatic Vacuum Regulator:

▲WARNING Hazardous suction. Can trap or tear hair or body parts. Install vacuum regulator on all high-vacuum systems.

- Every system requires a vacuum regulator for safe operation.
- Regulator provides vacuum relief in case cleaner suction is blocked.
- Black rubber diaphragm must always be submerged. If it sucks air, the pump will lose prime, which could damage the pump.

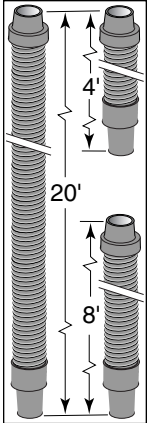

Hose:

- The unit includes a 20' hose, an 8' hose, and a 4' hose which will provide excellent coverage in pools up to 27'.
- For pools larger than 27', add an 8' extension hose. (Order No. GW9511; purchase locally).
- For pools smaller than 24', try the three hoses together. If 32' is too much hose, remove the 8' section and use only 24' of hose.
- The hose was designed specifically for the cleaner. Use of a different type of hose will reduce the cleaner's performance.

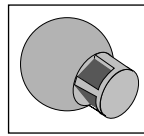

Flow Director:

- Install the flow director only if your existing inlet fitting in pool does not give the desired results.
- For best cleaning action, angle the flow down 45° in a fan out from pool side (see illustration below).

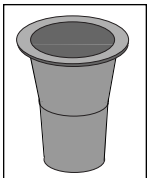
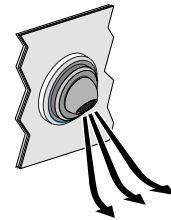

Reducer Cone:

- Adapts hose to some skimmers.
- Keeps hose in place in skimmer when pump stops.

Brush Adjustment

NOTICE: Bristle wear, pool bottom, temperature, etc., will all affect cleaner operation. Use these general guidelines to adjust your cleaner for best performance. Cleaner is factory set at No. 1.

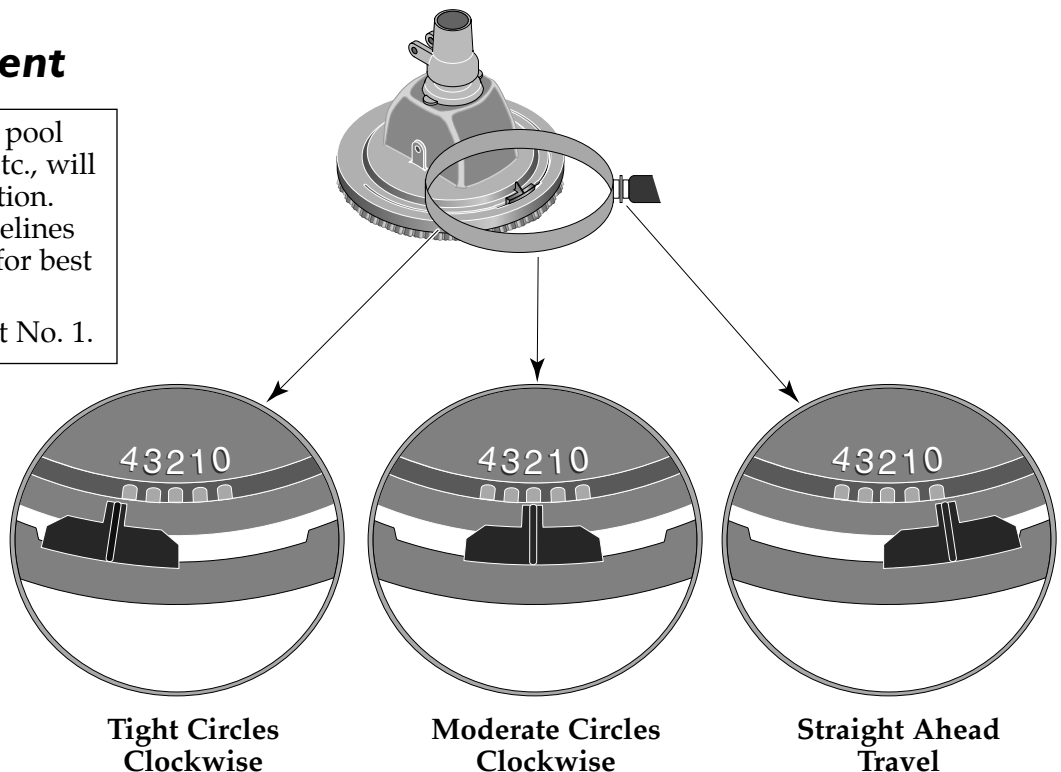

Installation

STEP 1: Straighten Hose

Remove hose from box and lay it out in the sun to straighten.

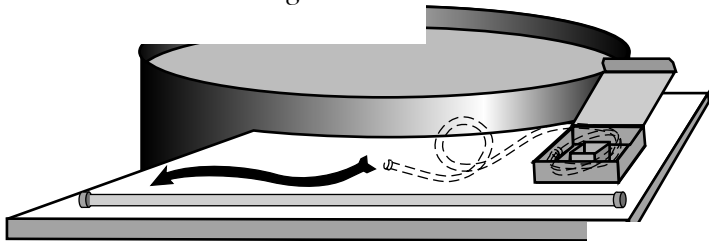

STEP 2: Check Parts

Make sure you have all parts to pool cleaner.

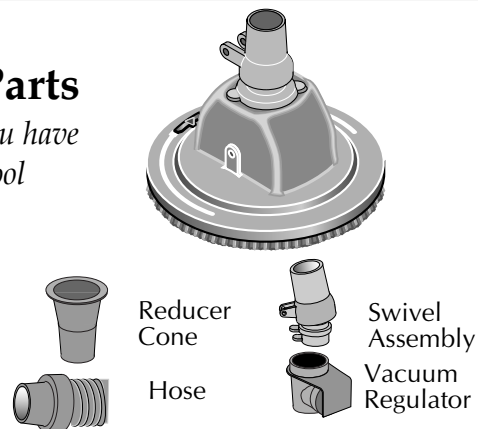

STEP 3: Clean System

- A. While the hose is relaxing, clean and backwash your filter system, skimmer and pump baskets.
- B. Close Main Drain if your pool has one.
- C. Start Pump.

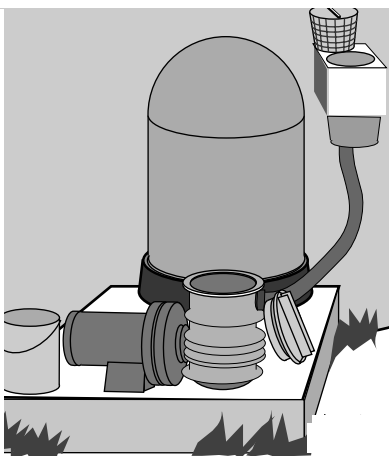

STEP 4: Assemble Cleaner

- A. Insert swivel assembly into cleaner body and twist 1/4 turn clockwise to lock.
- B. Set brush adjuster to '0'.
- C. Slide long hose cuff over swivel assembly to install hose.

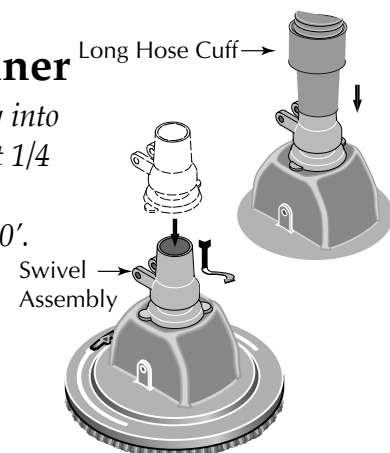

STEP 5: Submerge Cleaner

- A. Start pump.
- B. Turn cleaner upside down, submerge, and feed hose down side of pool wall to fill hose with water.

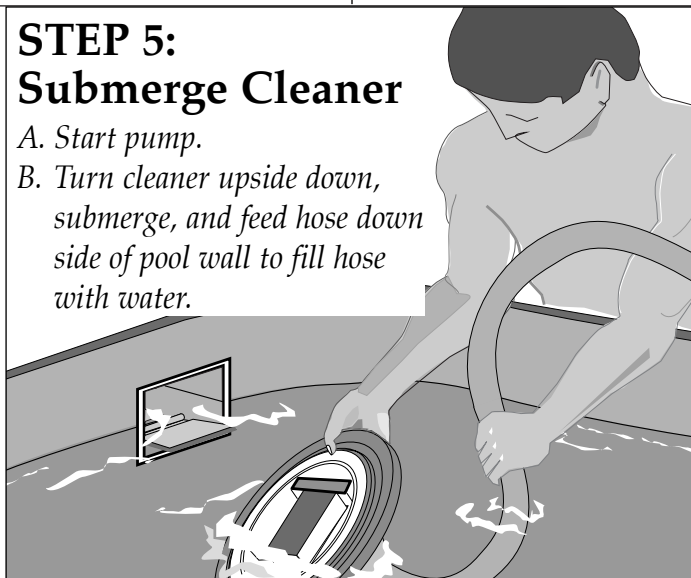

Installation

STEP 6: Connect Hose

With filter system running, connect hose to skimmer or to suction port. See below for various connections.

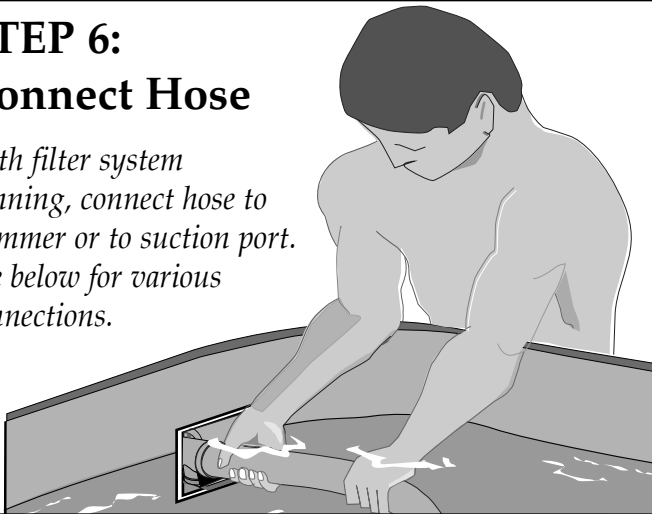

STEP 7: Extend Hose

For best results:
With cleaner running and submerged, pull hose to opposite end of pool and release.

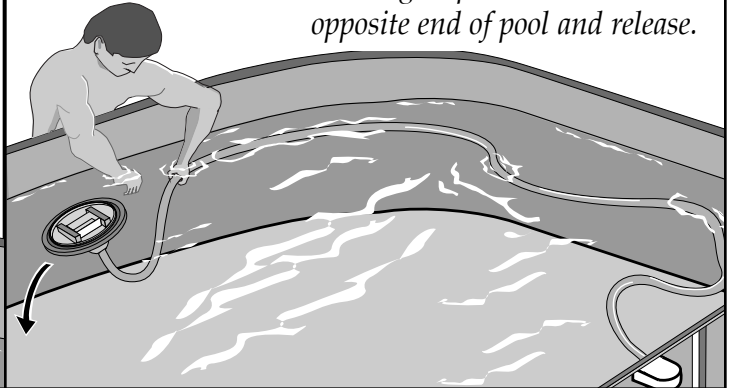

Hose Connections

Follow drawing that most closely resembles your skimmer installation.

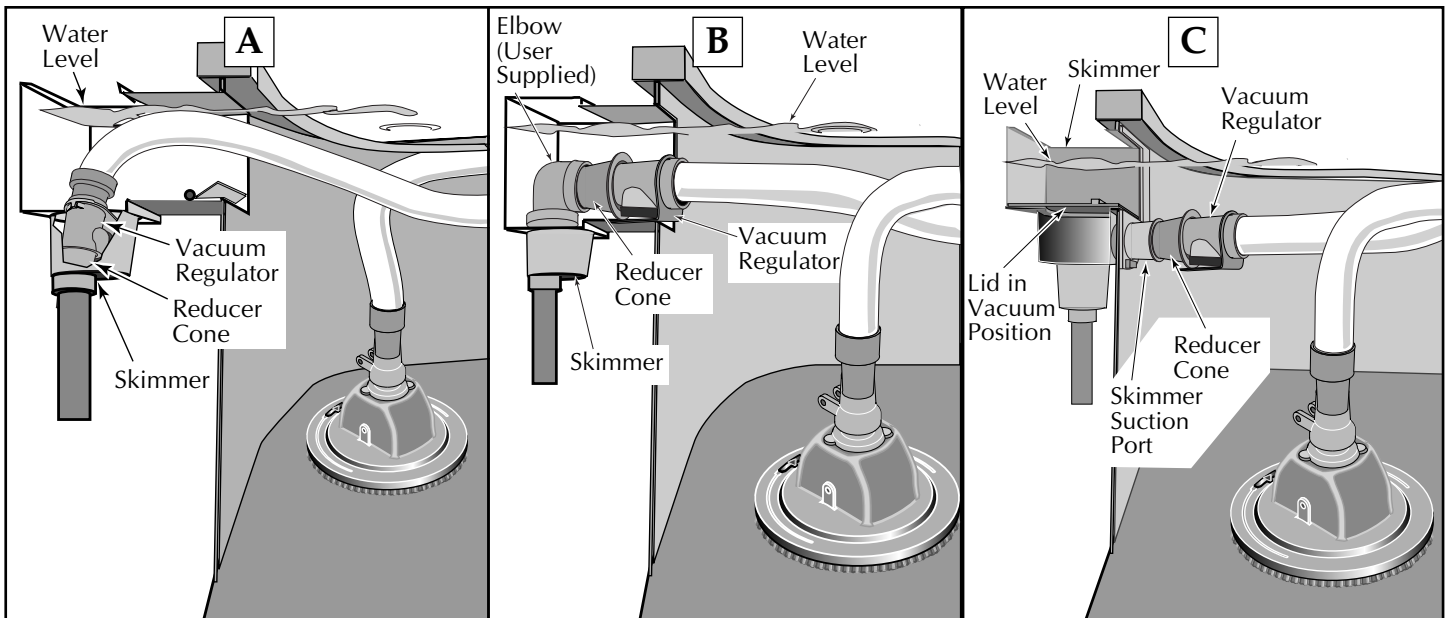

Final Checks (while cleaner is operating):

For Safety: No Bathers!

For Best Results:

- A. No ladders.
- B. No toys.
- C. No floating chlorinators.
- D. Close main drain if your pool has one.

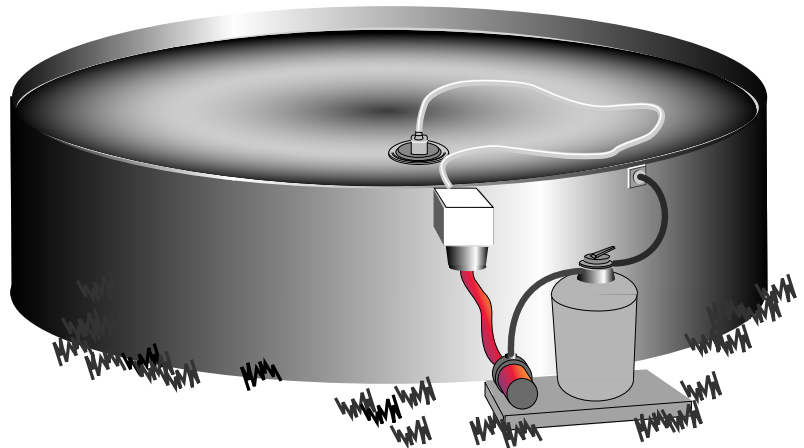

Troubleshooting

Situation	Solution
Cleaner moves slowly or not at all.	<ul style="list-style-type: none">• Backwash and clean filter. Empty all baskets.• Clear debris from oscillator or hose.• If hoses from skimmer to filter and back to pool are less than 1-1/2" diameter, replace with 1-1/2" hoses.• Pump in filtration system may be too small. Consult pool professional.• If your pool has a main drain (floor drain), close it during cleaner operation.
Cleans only perimeter of pool.	<ul style="list-style-type: none">• Make sure vacuum regulator is installed.• Set brush ring adjuster to a higher number.
Cleaner hovers in one area with hose fully extended.	<ul style="list-style-type: none">• Hose is too short. It should be approximately 5-8' longer than the full length of the pool. Buy an extension hose from your dealer to give adequate length.
Cleaner turns in clockwise circles only and only covers one section of pool.	<ul style="list-style-type: none">• Set brush ring adjuster to a lower number.
Oscillator runs too fast.	<ul style="list-style-type: none">• Make sure vacuum regulator is installed. (the regulator marked "50" will slow it the most).• If your system has a return valve, gradually close it until oscillator runs at the desired speed.
Hose keeps coiling up.	<ul style="list-style-type: none">• For best results, when hose is not in use, store it flat and straight.• Lay hose out in the sun (flat and straight) for a few hours.• Hose is too long; remove 8' section.
Pool not completely clean in four hours.	<ul style="list-style-type: none">• Any cleaner may miss a spot. Spot clean pool by attaching a vac-pole (telepole) to cleaner and steering it (see Page 5).• Try different brush ring adjuster settings (0-4) until the cleaner gives the desired results.• The cleaner was not designed to work under all solar covers.• Strong winds may interfere with complete cleaner coverage.
Cleaner flips on its side when pump stops.	<ul style="list-style-type: none">• This is normal if filter system develops a backpressure surge when the pump stops. The cleaner will right itself when system is restarted.
Hose comes loose when pump stops.	<ul style="list-style-type: none">• Use reducer cone in skimmer.
Cleaner sticks to pool bottom or pool main drain.	<ul style="list-style-type: none">• Install diaphragm marked "50" in vacuum regulator.• Check inner brush ring for excessive wear.

If you have any questions, please call 1-800-752-0183

Repair Parts – Model GW8000

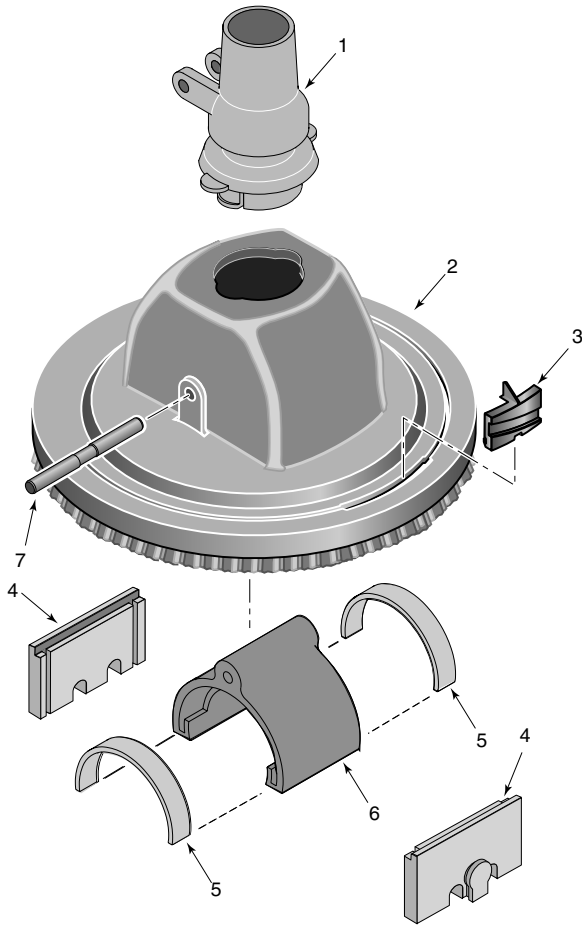

Optional Accessories

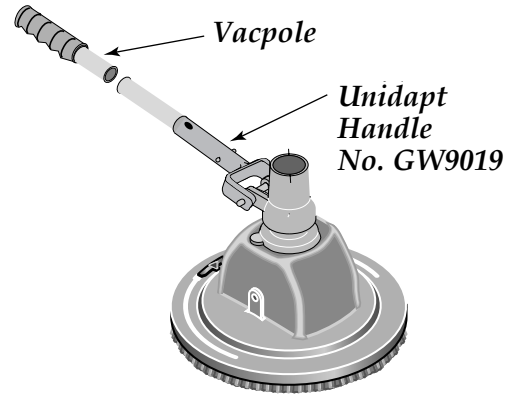

Key No.	Part Description	Qty.	Part No.
1	Swivel Assembly	1	GW9012
2	Pool Cleaner Body (With Bristles)	1	*
3	Ring Adjuster	1	41100-0026
4	Oscillator Impact Bumper (Pkg of 2)	1	41100-0027
5	Oscillator Seals (Pkg of 2)	1	GW9004
6	Oscillator Kit (Includes Seals)	1	GW9003
7	Axle Shaft	1	GW9002
•	Flow Director	1	GW9014
•	Replacement Hose Kit (1 each 20', 8', and 4' Hose)		GW9516
•	20' Hose	1	GW9521
•	8' Hose	1	GW9511
•	4' Hose	1	GW9519

• Not illustrated. * If body fails, order GW8000.

Oscillator Removal

To remove Oscillator from cleaner, tip cleaner on to its side, support side of housing, and tap axle shaft out of body.

Oscillator will now slide out of cleaner body. Oscillator impact bumpers can be pried out of slots in cleaner body (they slide towards bottom of cleaner).

To replace, reverse procedure.

STA-RITE LIMITED WARRANTY

Pumps, filters, skimmers, underwater lights (except bulbs), accessories and fittings manufactured by Sta-Rite are warranted to be free of defects in material and workmanship for one (1) year from date of installation.

Product specific warranties: **Year from date of installation**

<i>HRPB, DEPB, System 3, System 2 and Posi-Clear</i>	
Tanks	10 years
Internal filter components and valves	1 year
<i>Max-E-Therm - Pool/Spa Heaters</i>	
Heater Enclosure only (Upper RH & LH; lower enclosure; and control board enclosure)	2 years
<i>Automatic Pool Cleaners including Hose</i>	
	2 years
<i>Cristal-Flo filters - Tanks</i>	
Valve and internal components.	10 years pro-rated*
	1 year
<i>Posi-Flo II - Tanks</i>	
Elements	10 years
	1 year
<i>PRC Cartridge -</i>	
Filter Tanks	5 years pro-rated (1st 2 years full)
Elements	1 year
<i>System 2 Above Ground Systems - Tanks</i>	
Pumps / Platform and Internals	10 years
	1 year
<i>Pumps</i>	
When equipped with A.O. Smith 2-compartment motors (Does not include pumps sold as part of a systems package)	1 year
	2 years
<i>Traps / In-Line Strainers</i>	
	1 year
<i>Vertical Commercial Filter - Tanks</i>	
Internals	10 years
	1 year
<i>Horizontal Commercial Filter</i>	
Tanks	5 years
(Years 6-9, Prorated declining 20%/year, Yr. 10 - 10%)	
Internals	1 year

* Full warranty coverage is in effect for one year after installation. The pro-rated warranty covers the *tank only* during the 2nd through 10th year after installation. The amount covered decreases by 10% each year. (ie., 2nd year 90% covered, 3rd year 80% covered, etc.)

The foregoing warranties relate to the original consumer purchaser ("Purchaser") only. Sta-Rite shall have the option to repair or replace the defective product, at its sole discretion. Purchasers must pay all labor and shipping charges necessary to replace the product covered by this warranty. Requests for warranty service must be made through the installing dealer. This warranty shall not apply to any product that has been subject to negligence, misapplication, improper installation or maintenance, or other circumstances which are not in Sta-Rite's direct control.

This warranty sets forth Sta-Rite's sole obligation and Purchaser's exclusive remedy for defective products.

STA-RITE SHALL NOT BE LIABLE FOR ANY CONSEQUENTIAL, INCIDENTAL OR CONTINGENT DAMAGES WHATSOEVER.

THE FOREGOING WARRANTIES ARE EXCLUSIVE AND IN LIEU OF ALL OTHER EXPRESS WARRANTIES. IMPLIED WARRANTIES, INCLUDING BUT NOT LIMITED TO THE IMPLIED WARRANTIES OF MERCHANTABILITY AND FITNESS FOR A PARTICULAR PURPOSE, SHALL NOT EXTEND BEYOND THE DURATION OF THE APPLICABLE EXPRESS WARRANTIES PROVIDED HEREIN.

Some states do not allow the exclusion or limitation of incidental or consequential damages or limitations on how long an implied warranty lasts, so the above limitations or exclusion may not apply to you. This warranty gives you specific legal rights and you may also have other rights which vary from state to state.

Supersedes all previous publications.

Sta-Rite Industries
293 Wright St., Delavan, WI 53115

▲ Retain Warranty Certificate (upper portion) in a safe and convenient location for your records.

▼ DETACH HERE: Fill out bottom portion completely and mail within 10 days of purchase/installation to:
Sta-Rite, Attn: Warranty Dept., 293 Wright St., Delavan, WI 53115



Warranty Registration Card

Name _____

Address _____

City _____ State _____ Zip _____

Purchase Date _____

Product Purchased _____

New installation Replacement

Type of Pool Inground Vinyl Fiberglass Gunite

Size of Pool _____

Years pool has been in service less than 1 1-3 3-5 5-10

Purchased from: _____

Company name _____

Address _____

City _____ State _____ Zip _____

Please send me more information on these other products from Sta-Rite.

- Pumps Filters Automatic Pool Cleaners
 Maintenance Equipment Test Strips
 Heaters