

INTER-FAB
inter-fab.com

X-STREAM™ SLIDE
Assembly & Installation Instructions



3050 S. ALVERNON WAY • TUCSON, AZ 85713
520.790.7040 • 800.737.5386 • FAX 520.790.7127

inter-fab.com

TABLE OF CONTENTS:

Getting Started.....2

Safety First3

Left Turn Water Stub-Up (Fig. A1).....4

Left Turn Footprint (Fig. A2)5

Right Turn Water Stub-Up (Fig. A3).....6

Right Turn Footprint (Fig. A4)7

Parts Required (Fig. B).....8

Step 1: Step Support Assembly, Handrails, Top Section.....9-10

Step 2: Slide Legs 11

Step 3: Assembly of Flume Sections.....12

Step 4: Erecting the Assembled Slide 13

Step 5: Anchoring Slide to Deck 14

Step 6: Water Supply Hook-Up 15

Step 7: Final Steps of Assembly..... 15

Photographic Tips16-18

Exploded View of X-Stream Slide..... 19

Parts List (corresponds with exploded view).....20

Slide Care & Maintenance.....21

Inter-Fab Limited Warranty.....22



Getting Started

The following Assembly and Installation instructions are listed in the correct sequence for a straightforward assembly of the X-stream™ Slide. Please read and understand all instructions before beginning installation. A two-person crew is recommended for best results, as the assembled slide is very long, and difficult for one person to handle. The Footprint Templates (**Fig. A2** and **Fig. A4**) are for reference only, and it is strongly recommended that the slide not be permanently anchored to deck until the proper time in the assembly order.

Choose the Water Stub-up Location and Footprint Template for the applicable direction of the X-Stream™ slide from the following figures:

Fig. A-1: Water Stub-up Location, Left Hand Slide

Fig. A-2: X-stream Footprint, Left Hand Slide

Fig. A-3: Water Stub-up Location, Right Hand Slide

Fig. A-4: X-Stream Footprint, Right Hand Slide

For a List of Parts, and Required Tools, See Fig. B, and Schedule One (pages 8 & 9)

Important Note: Page 19 is an exploded view of the X-Stream™ slide. Page 20 is a list and description of the hardware used to assemble the X-Stream™ slide.

SAFETY FIRST!

This equipment is designed for residential pool use only; NOT for commercial use.

- When installed according to instructions, this product substantially conforms to Consumer Product Safety Standard Guidelines.
- Maintain adult supervision at all times.
- Use slide in a feet first sitting position only.
- Slide only when slide path is free of swimmers and obstructions.
- Only one person on slide at a time.
- No standing on flume of slide.
- No jumping or diving from slide.
- Weight Limit = 250 lbs.

* *The exit point of the flume can be no higher than 20" above water.*

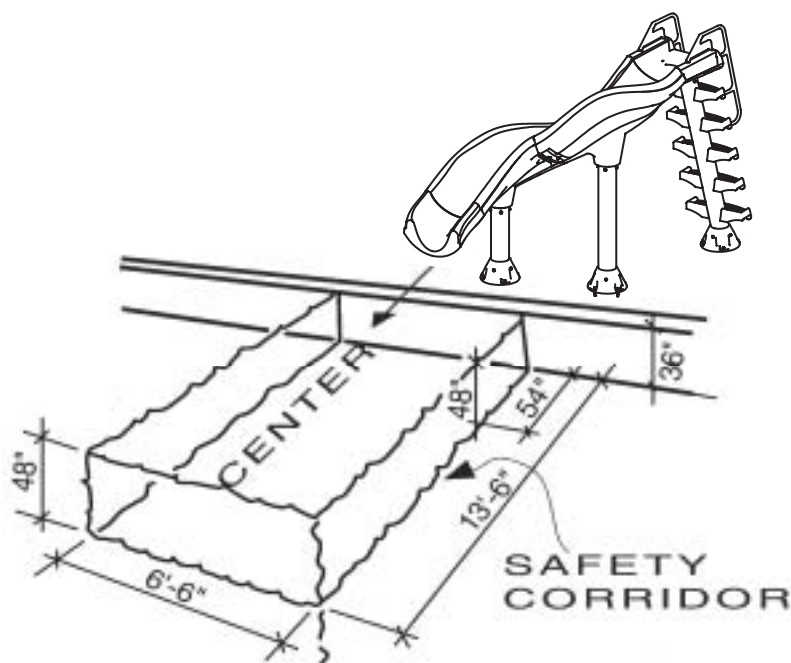

X-STREAM™ - LEFT TURN WATER STUB-UP

This dimension may be greater than 4'11", depending on final slide location on deck, rotated about fixed point. It must not be less than 4'11". (refer location of fixed point.)

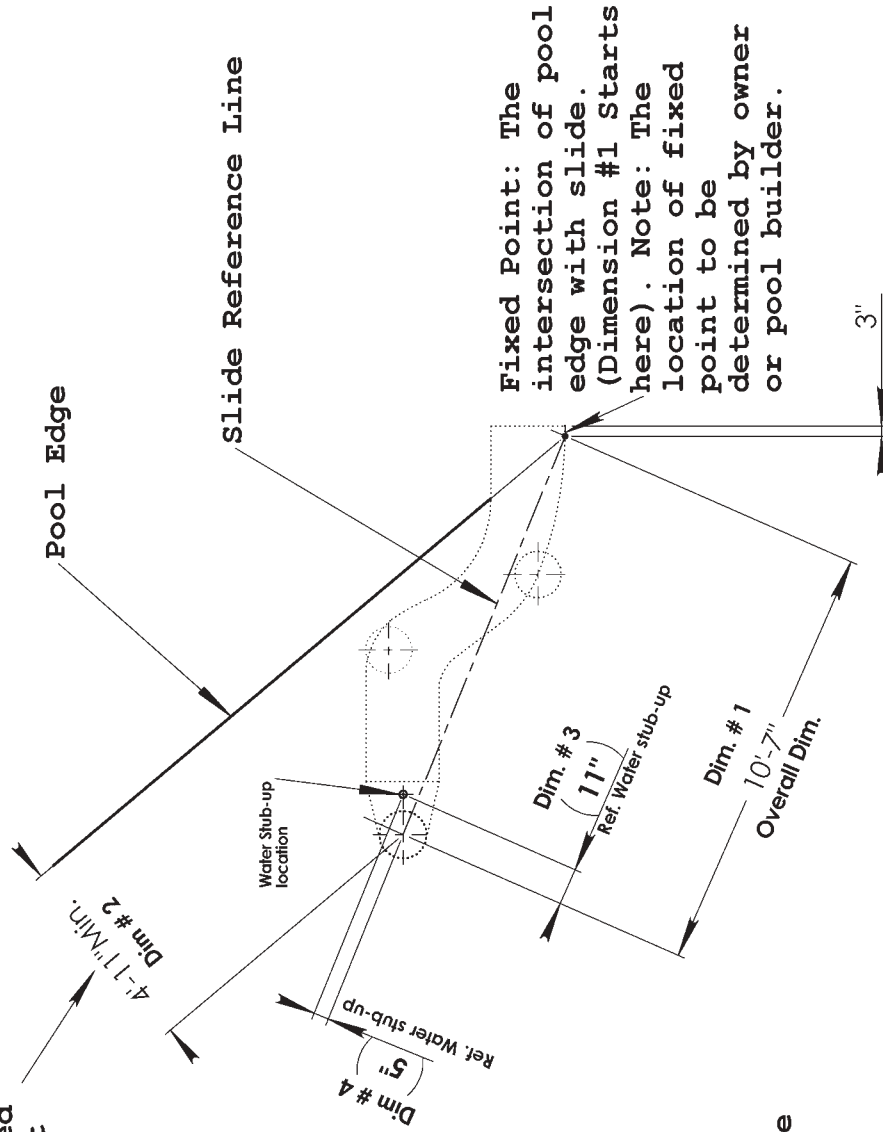

Fixed Point: The intersection of pool edge with slide. (Dimension #1 Starts here). Note: The location of fixed point to be determined by owner or pool builder.

- NOTES:**
1. Ref. Means for reference use only.
 2. All dimensions subject to change without prior notice.
 3. Dimensions #1, #2, #3, #4 are the order of construction.

FIG. A1

X-STREAM™ - LEFT TURN FOOTPRINT

This dimension may be greater than 4'11", depending on final slide location on deck, rotated about fixed point. It must not be less than 4'11". (refer location of fixed point.)

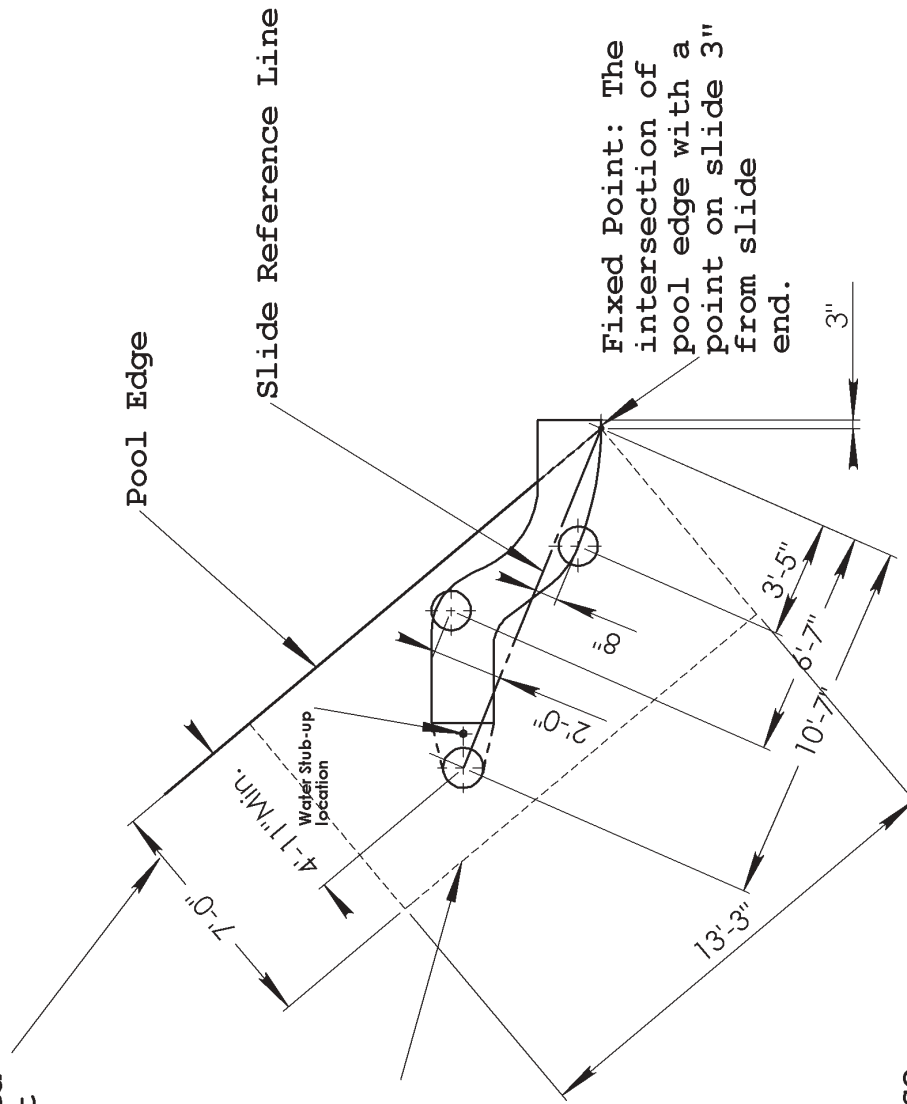

Outline of recommended concrete deck for X-stream slide. (By others)

NOTES:

1. Ref. Means for reference use only.
2. All dimensions subject to change without prior notice.

FIG. A2

X-STREAM™ - RIGHT TURN WATER STUB-UP

NOTES:

1. "Ref". means "for reference use only".
2. All dimensions subject to change without prior notice.
3. Dimensions #1, #2, #3, #4 are the order of construction.

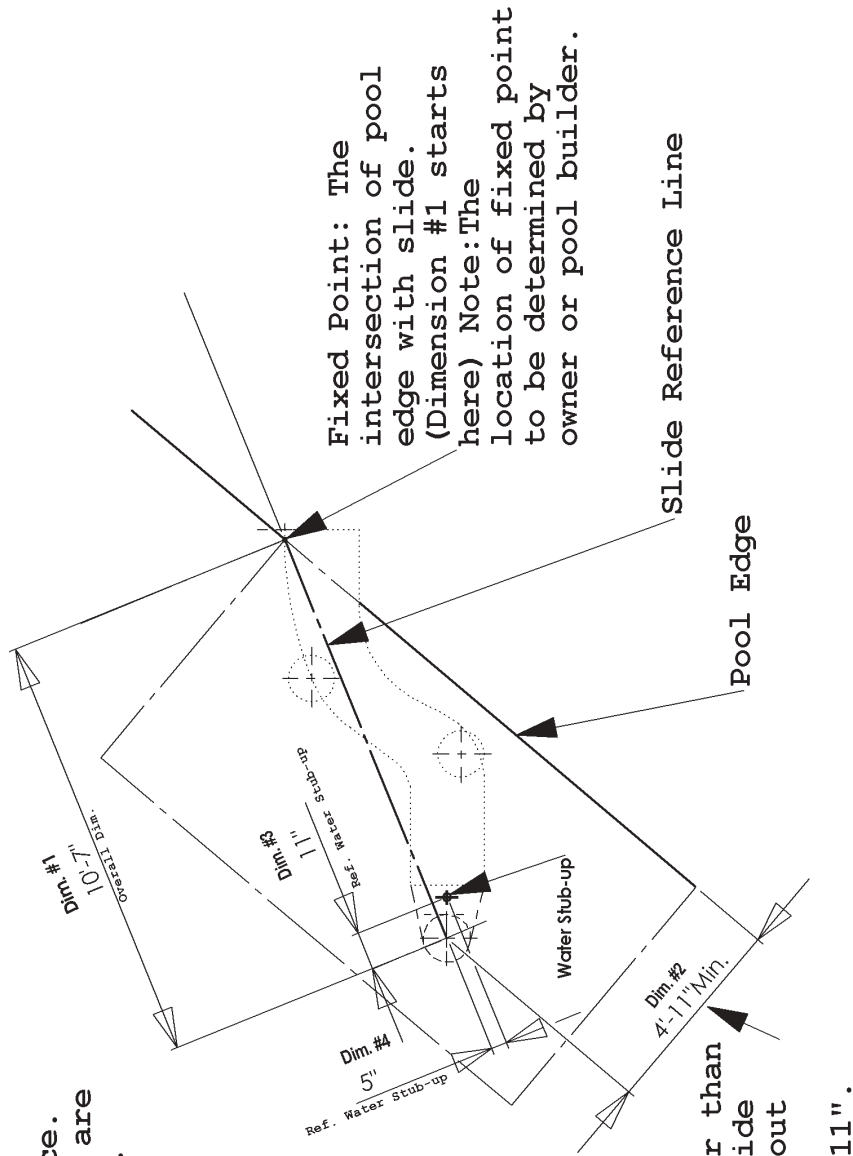

This dimension may be greater than 4'-11" depending on final slide location on deck, rotated about fixed point (Edge of Slide). It must not be less than 4'-11".

FIG. A3

X-STREAM™ - RIGHT TURN FOOTPRINT

NOTES:

1. Ref. Means for reference use only.
2. All dimensions subject to change without prior notice.

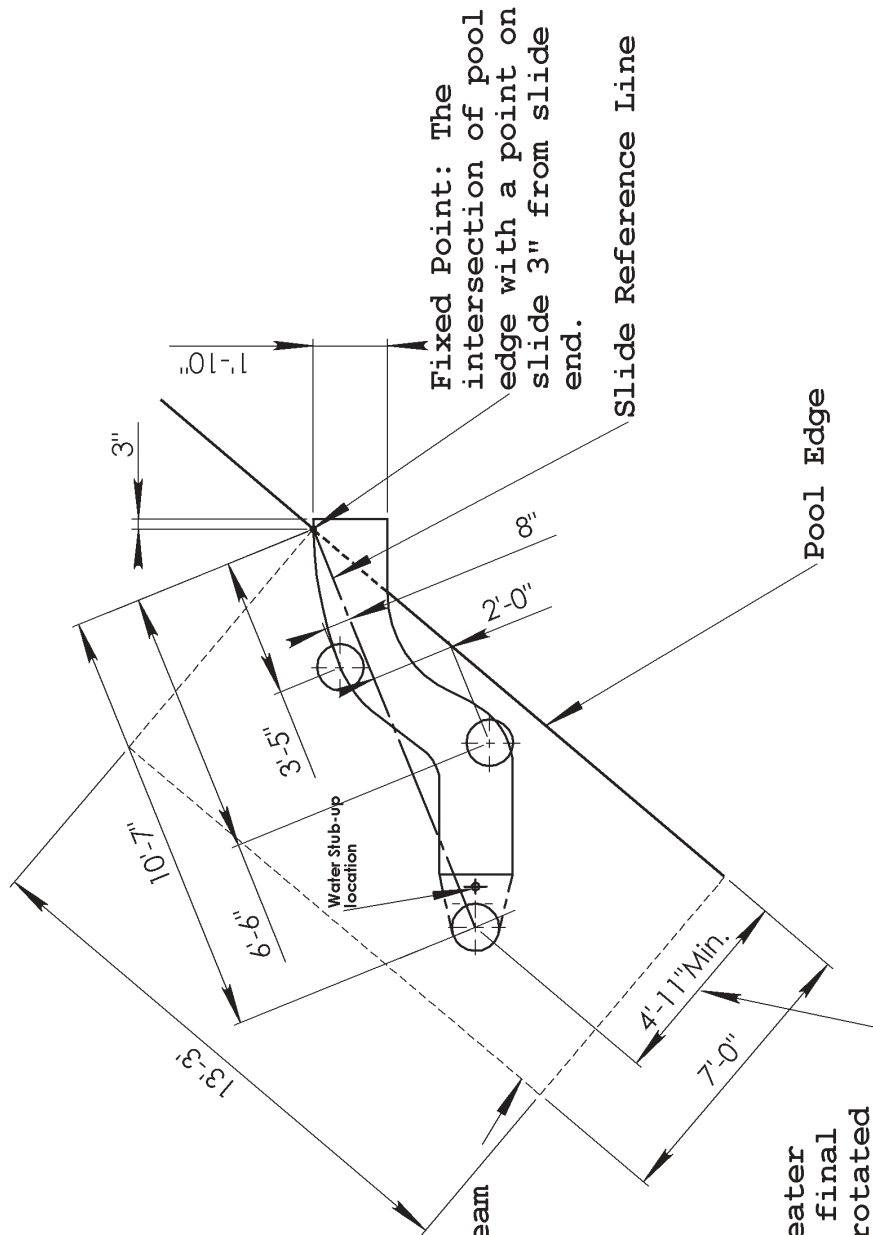

Outline of recommended concrete deck for X-stream slide. (By others)

This dimension may be greater than 4'11", depending on final slide location on deck, rotated about fixed point. It must not be less than 4'11". (refer location of fixed point.)

FIG. A4

FIG. B: PARTS REQUIRED

IMPORTANT: For a Left Hand Slide, Flume A, B is upper flume, and C, D is the lower flume, in that order. For a Right Hand Slide, C, D is the upper flume and A, B is the lower flume. Flumes are labeled A, B or C, D in small letters centered on flanges.



A,B Flume



C,D Flume

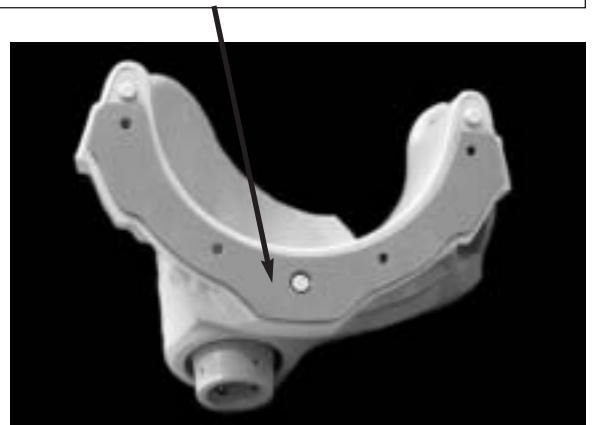

Bottom Section



Top Section



Leg Foot (2)



Step Support Foot



Step Support



Long Leg



Short Leg



Handrail



Hardware Kits (5)

NOTE: In-line ball valve (not shown) is included by Mfr.

SCHEDULE ONE

Tools required for assembly and installation of X-stream slide:

NOTE: USE PROVIDED LUBRICANT ON ALL BOLTS!

1. Hammer
2. 3/8" drive ratchet
3. 3/8" x 6" ratchet extension
4. 1/2" deep socket (deep socket is necessary)
5. 9/16" socket
6. 9/16" box end ratchet wrench
7. Drill with 3/8" masonry bit
8. Tape measure
9. PVC Pipe Cutter

List of Required Tools

ASSEMBLY AND INSTALLATION INSTRUCTIONS

For left hand slides, flume A, B is the upper flume and C, D is the lower flume, in that order. For right hand slides, flume C, D is the upper flume and A, B is the lower.

STEP ONE: Attaching the Step Support Assembly & Handrails to Top Section

HINT: Foot receiver for step has a **slant** to it; the other two foot receivers do **not** slant. Foot receiver for step uses the one long bolt **in hardware set #1**. There are ten bolts the same size and one long bolt. **USE PROVIDED LUBRICANT ON ALL BOLTS.**

A. Install foot receiver on 6" PVC pipe step support assembly using 3/8" x 2" bolts at two locations, and 2-1/2" bolt for the location directly underneath the step support assembly column. Push bolt through 3/8" flat washer, through pre-drilled holes in PVC and foot receiver, through 3/8" flat washer, and through 3/8" nylon locking nut. This foot receiver contains only three holes for complete attachment. **(Fig. B - Step Support Foot) Use hardware set #1.** Tighten all connections.

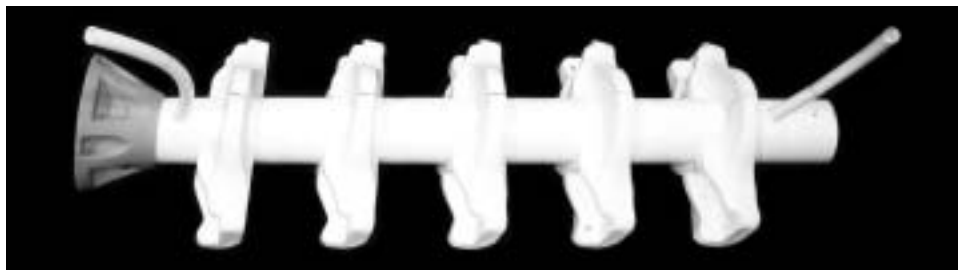
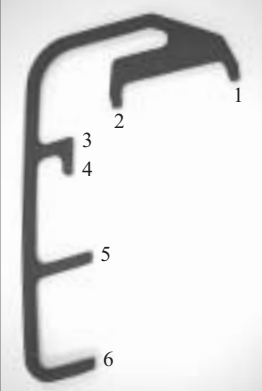

Fig. 1

B. Connect step support assembly to top section (**Fig. 2**). This assembly may be done with the top section on ground on its side. Insert 6" PVC step support assembly into receiver in top section: Using 3/8" x 2" bolts **provided in hardware set #3**, push bolt through 3/8" lock washer; through 3/8" flat washer; through pre-drilled hole in PVC pipe and into pre-inserted nut in the receiver in top section. Make sure orientation of top section is such that handrail will connect to both top section and step section. Tighten connections slightly. Connect handrail to the top section of the slide and to steps before attaching the top section of the upper flume.

C. NOTE: Handrails must be installed with X-Stream label facing out. **TIP: See pages 16 & 17 for more detail.** Thread the appropriate length of allthread into the 6 nuts of each handrail. Allthread will screw in about 1/2", hand tighten only. Gently spread the handrail to allow installation on top section. When installed properly, allthreads should extend through the top section of the slide and through the backside of steps. On position 1-4 start the flange nut (hand tighten, no washers). On the steps, position 5-6, install flat washer then flange nut. (Hand tighten only.)



All Thread Required for Each Handrail (2 Handrails)

- Position 1. 1ea - 5/16" x 2 1/2" allthread
- Position 2. 1ea - 5/16" x 3" allthread
- Position 3. 1ea - 5/16" x 2" allthread
- Position 4. 1ea - 5/16" x 2" allthread
- Position 5. 1ea - 5/16" x 2 1/2" allthread (use flat washer)
- Position 6. 1ea - 5/16" x 2 1/2" allthread (use flat washer)

Schedule Two: Handrail Hardware



HINT: These are the actual allthread sizes.
USE PROVIDED LUBRICANT ON ALL BOLTS AND ALLTHREADS.

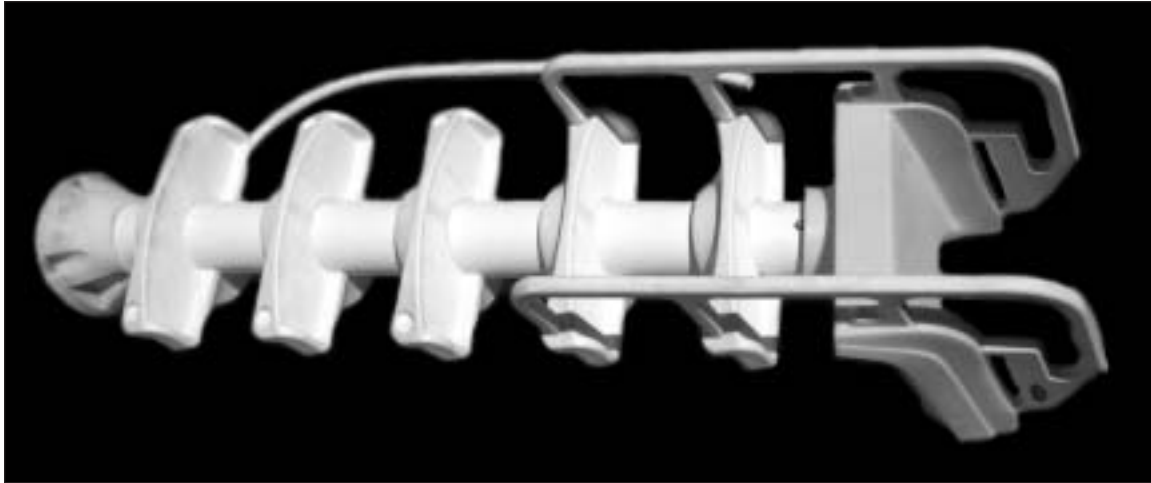

Fig. 2: Ladder Step Support Sub-Assembly

STEP TWO: Attaching the Slide Legs

HINT: Do not confuse the four foot receiver holes at the bottom of the leg pipe with the four flume receiver holes at the top. The foot receiver holes are 4-1/2" from the end of the pipe. PVC leg will sit flush to the floor when installed in the foot receiver correctly.

Install remaining foot receivers on the long and short legs, using 3/8" x 2" bolts in four locations. Push PVC pipe all the way to the bottom of the foot receiver. Push 3/8" x 2" bolt through 3/8" flat washer, through pre-drilled holes provided in PVC pipe and foot receiver, through 3/8" flat washer, and through 3/8" nylon locking nut. Tighten all connections. **(Fig. 3, Fig. 4 & Fig. 5) Use hardware set #1.**



Fig. 3



Fig. 4



Fig. 5

Short Leg and Long Leg with Foot Attached
(shown with 12" ruler)

USE PROVIDED LUBRICANT ON ALL BOLTS.

STEP THREE: Assembly of Flume Sections

HINT: The flume may be assembled on the ground, with parts upside down or on their sides. Assemble on the box or packaging material to avoid scratching the flume. Hand tighten for now, tighten fully once flume sections are even.

A. Connect lower flume section to upper flume section using 3/8" x 3" thru bolts in four locations. **TIP: There are 3 factory installed gaskets, ensure a gasket is in place on the top section and the male end of both flume sections. (Fig. 6 & Fig. 7) Use hardware set #2.** Push 3/8" bolt through flat washer, through pre-drilled holes in flanges of both flumes, through flat washer, through lock washer, and through 3/8" nut. Hand tighten.

IMPORTANT NOTE: There is enough tolerance in the flange connections to provide a smooth and even transition between flumes on the sliding surface; usually, it will take the efforts of two people to ensure this: one to pull or push on the flumes at the flange connection, and one to tighten the bolts when the top surfaces are even. It is recommended that the two center bolts be tightened first. Once the flume sections are aligned, then tighten the two outer connections. NOTE: Make sure AB/CD or CD/AB orientation is correct for Left or Right hand slide as required. **(see note, Fig. B)**



Fig. 6

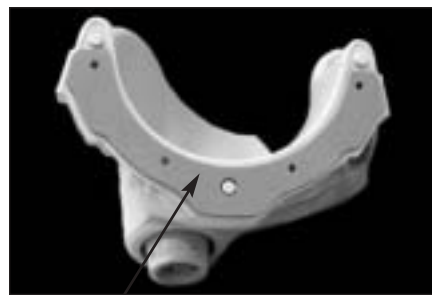

Gasket Fig. 7

B. Connect exit section to lower flume, using 3/8" x 2-3/4" thru bolts in four locations. Push 3/8" bolt through flat washer, through pre-drilled holes provided in both flanges, through flat washers, through lock washer, and through 3/8" nut. **(Fig. 8) Use hardware set #2.** Ensure a smooth, even transition of the sliding surface, then tighten the two center bolts first, then the two outer bolts.

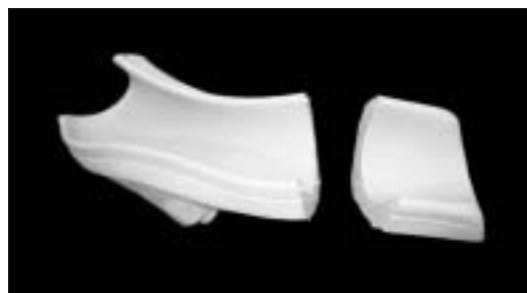

Fig. 8

USE PROVIDED LUBRICANT ON ALL BOLTS.

STEP FOUR: Erecting the Assembled Slide

A. Loosely install, legs to flumes: long leg to upper flume, short leg to lower flume, using 3/8" x 2" bolts **from hardware set #3**. Push bolt through lock washer, through flat washer, through pre-drilled hole provided in PVC pipe, and into pre-inserted nuts in flume leg receiver. **Do not tighten completely at this time. (Fig. 9)**



Fig. 9

B. TIP: See page 18 for more detail. Thread the 4 lengths of 3/8" x 2-1/2" allthread into the embedded nuts in the flange of the top section. **(Hardware set #2)** Allthread will thread in about 3/4" with 1-3/4" protruding from top section. (Hand tighten only.) Turn slide flume assembly upright, resting it momentarily on the two legs. Lean the ladder step support sub assembly against the upper flume section using the protruding allthreads as a guide. The allthread will align with the pre-drilled holes in the upper flume section. When in position, install a 3/8" flat washer, 3/8" lock washer and a 3/8" nut on each allthread, **(Hardware set #2)**. As in step 3, ensure gaskets are installed, then align and tighten uniformly, but do not over tighten.

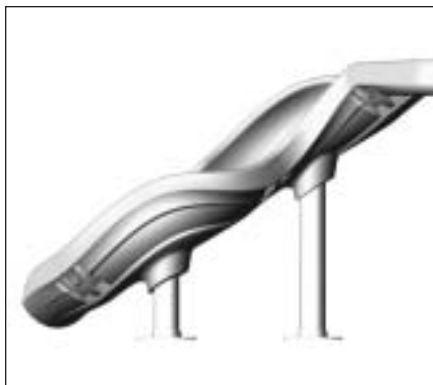
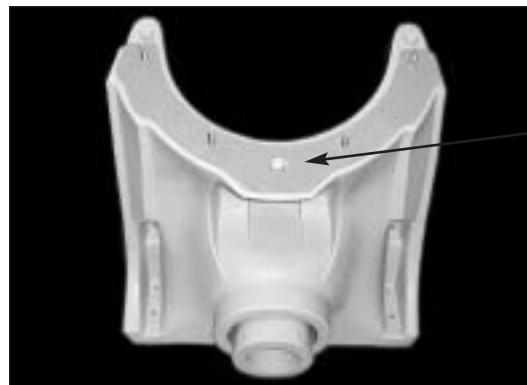

Fig. 10



Flexible Gasket required between all flanges.

Fig. 11

C. When long and short legs are completely plumb (ensure each leg is vertical by checking each leg at two points 90 degrees from each other), tighten all connections. **NOTE:** Slide step support system is designed for 16 degree slope which must be installed correctly for proper functioning of slide. **(Fig. 12)**

HINT: Now check alignment of flume sections; if necessary, loosen the bolts to adjust the flume. Tighten all connections after flume alignment check.

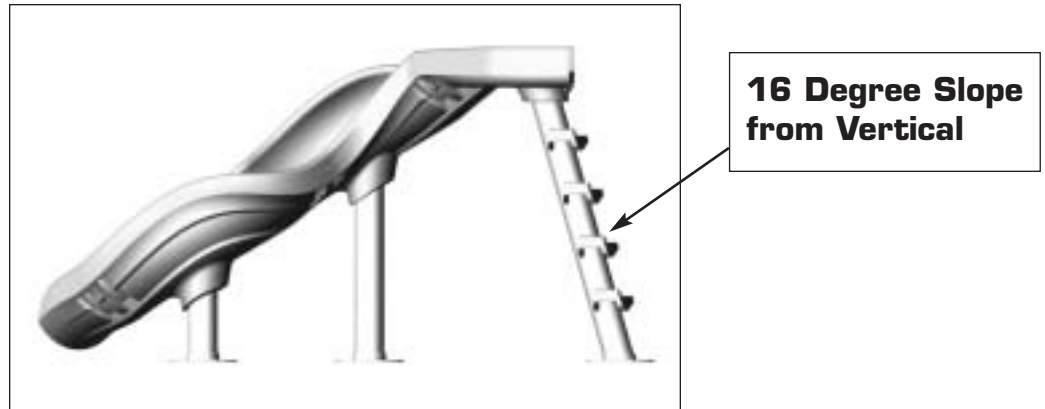

Fig. 12

STEP FIVE: Anchoring to Deck

- Position all foot receivers on deck in the correct location, ensuring the legs are plumb and the step support is at 16°, then carefully mark the locations of all anchor bolts. With proper care, the vertical leg anchor bolt holes can be drilled with leg foot receivers in position. After marking the bolt hole locations for the slanted step support anchor, move the slide to one side; these holes cannot be drilled with the slide in position due to interference with the steps.
- Move the slide aside to drill the slanted Step Support anchor bolt holes.
- Install Anchor Bolts at correct locations. Anchor bolt thread must protrude 1-1/2" above the deck. **Use Hardware Set #4.**
- Install foot receivers onto deck on the previously installed anchor bolts. **(Fig. 13)**
- Tighten all connections.

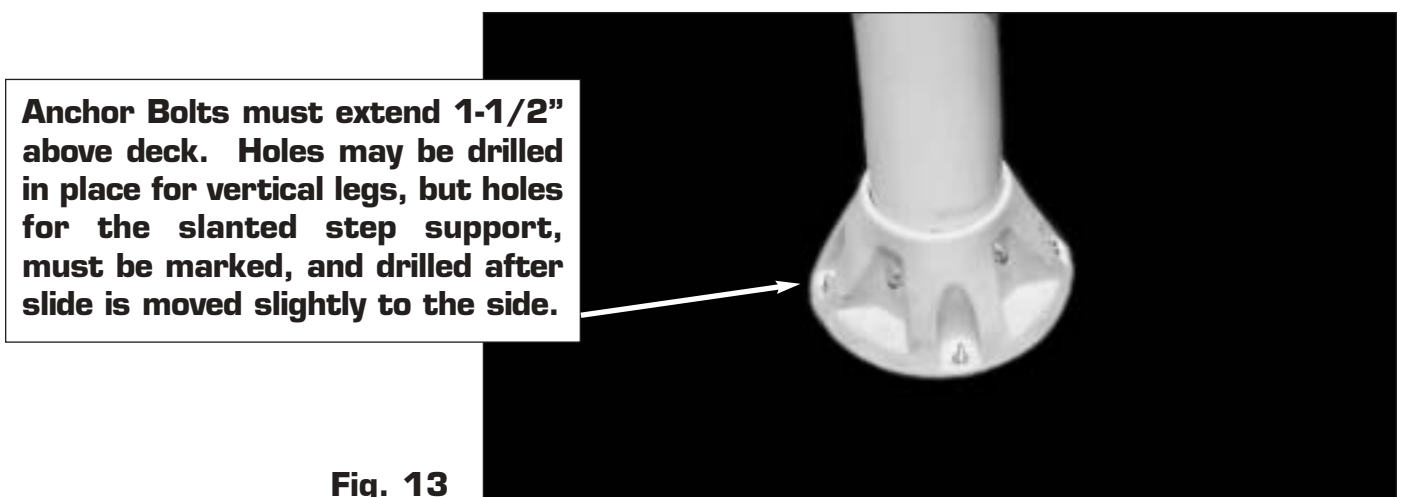

Fig. 13

STEP SIX: Connect Water Supply System

A. Connect bottom water system hose to stub-up as required, using proper connectors (not furnished) and in-line valve (furnished) as required. **(Fig. 14)**

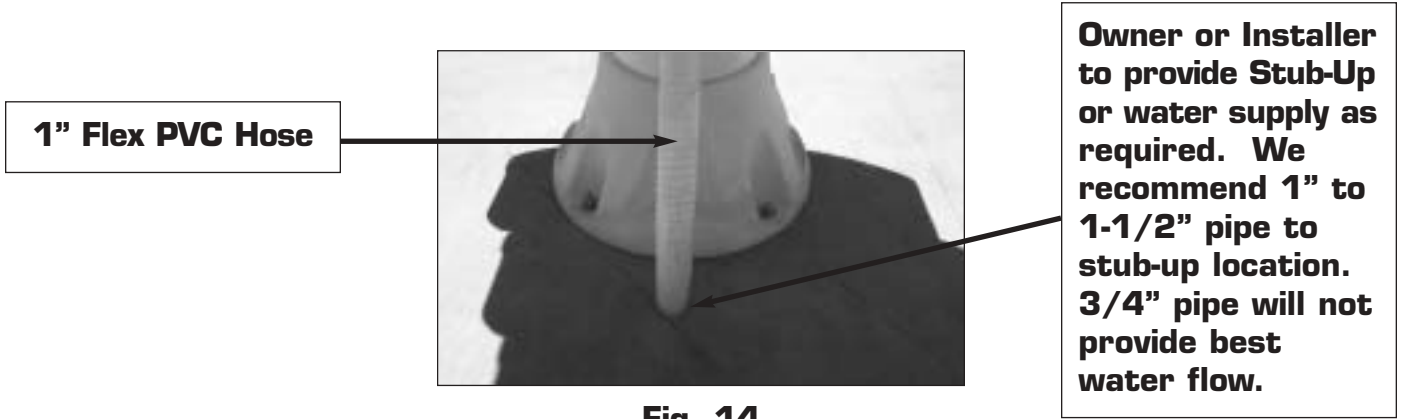

Fig. 14

B. Connect top hose section (cutting piping to fit as required) to the male adapter attached to top section. Use PVC primer and glue (not included) as required. **(Fig. 15 & Fig. 16) Use hardware set #6.**

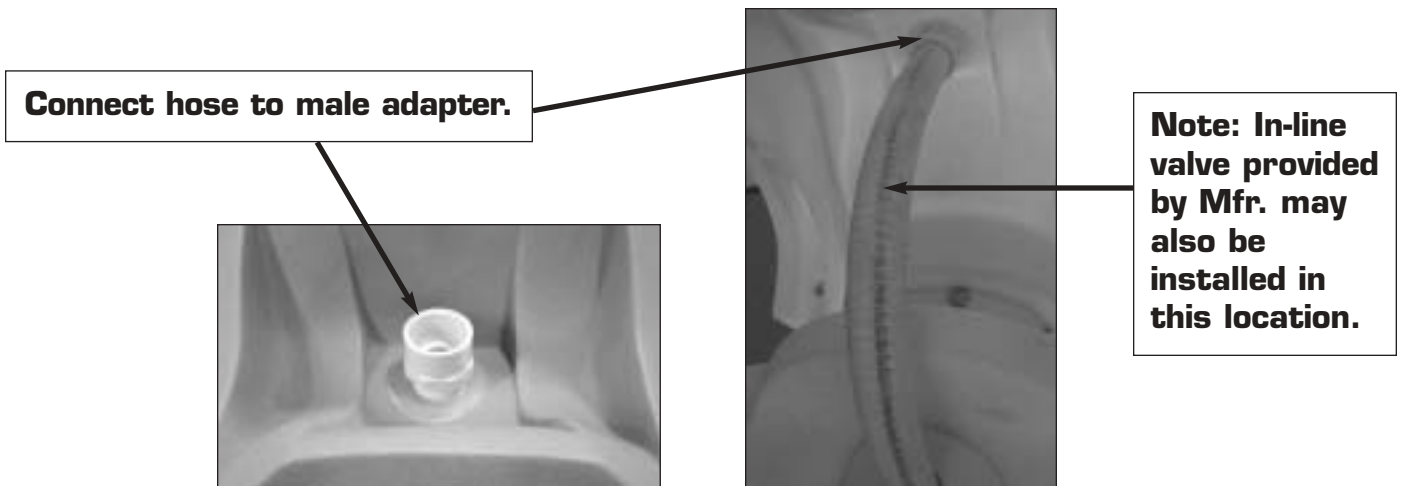

Fig. 15

Fig. 16

STEP SEVEN: Finish

- Install protective caps on all exposed bolts.
- Turn water supply on and check water flow.
- Clean Slide and dispose of all debris caused by the installation.

HINT: *It is recommended that after several days of use, all visible bolted connections be re-tightened as needed.*

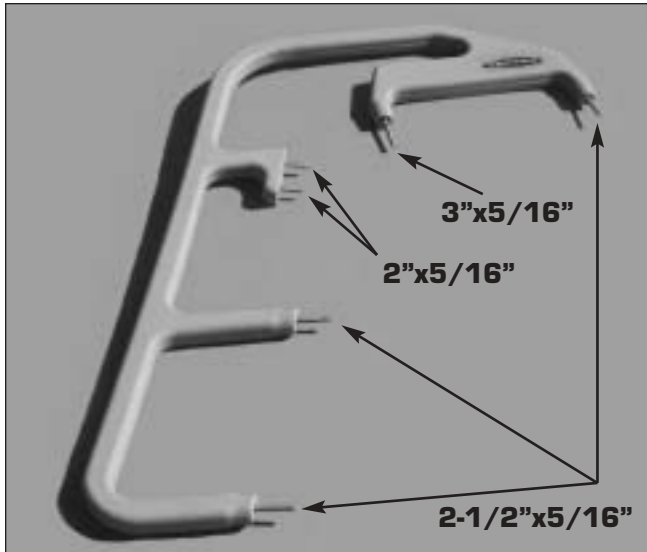

Hand tighten allthread into each of the 6 locations on the handrails. Ensure correct length of all thread is used at each location.

- 1 - 3"x5/16" allthread**
- 2 - 2"x5/16" allthread**
- 3 - 2-1/2"x5/16" allthread**

Make sure to use provided lubricant on the allthread before inserting into the embedded nuts.



Insert handrail into the top section first as illustrated. Push or pull the handrail apart until the allthreads pass through the 6 holes.

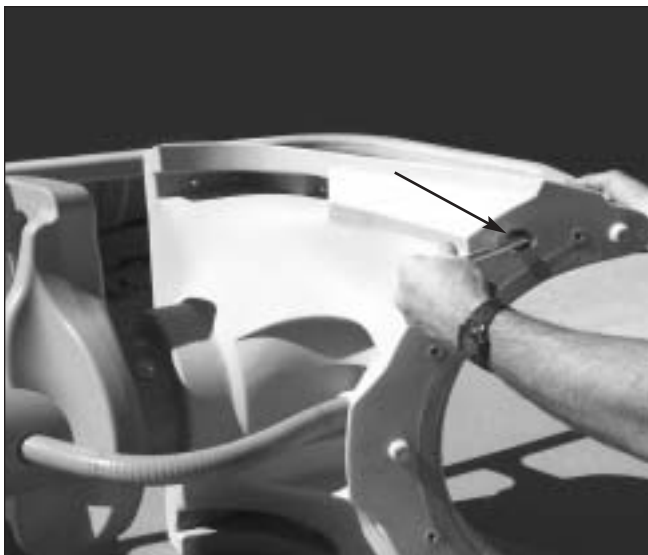

Place a flange nut into a socket with an extension and slip it into this hole. Hand tighten flange nut onto the allthread.

At this location only a flange nut is required. No flat washer or rubber cap is needed.

Make sure to use the provided lubricant on the flange nut threads before attaching to the allthread.

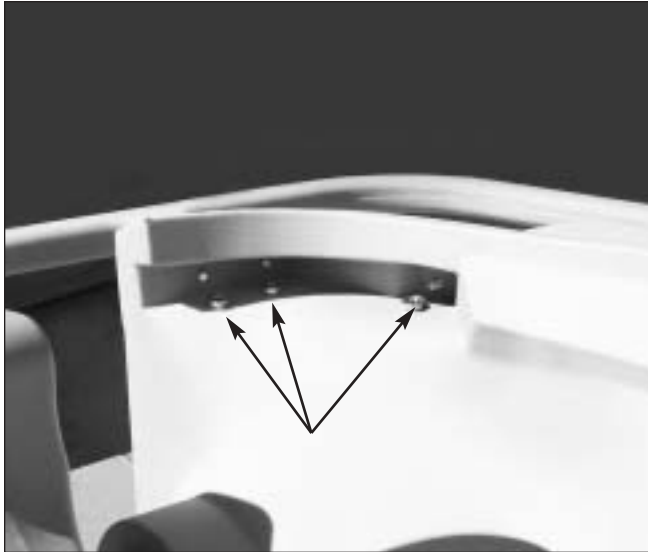

These 3 locations receive a flange nut and a rubber cap. A flat washer is not needed. Hand tighten.

Make sure to use the provided lubricant on the allthreads before attaching the flange nuts.

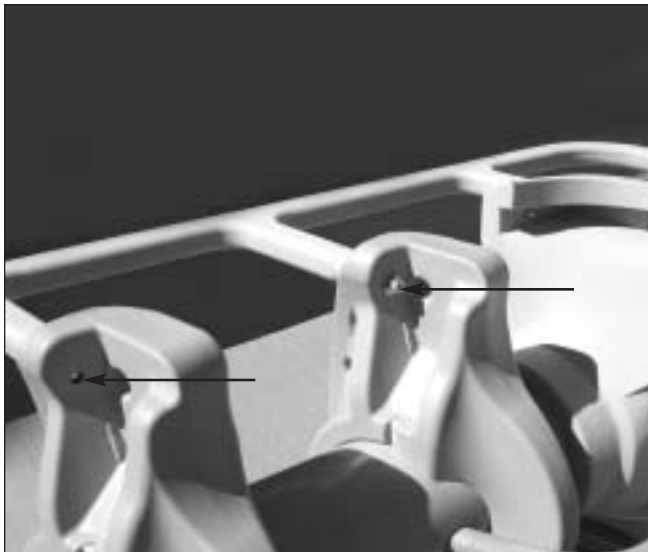

These two locations require a flat washer, flange nut and rubber cap. Hand tighten.

Make sure to use the provided lubricant on the allthreads before attaching the flange nuts.

NOTE: 1/8" - 1/4" of the allthreads will extend through the flange nut.

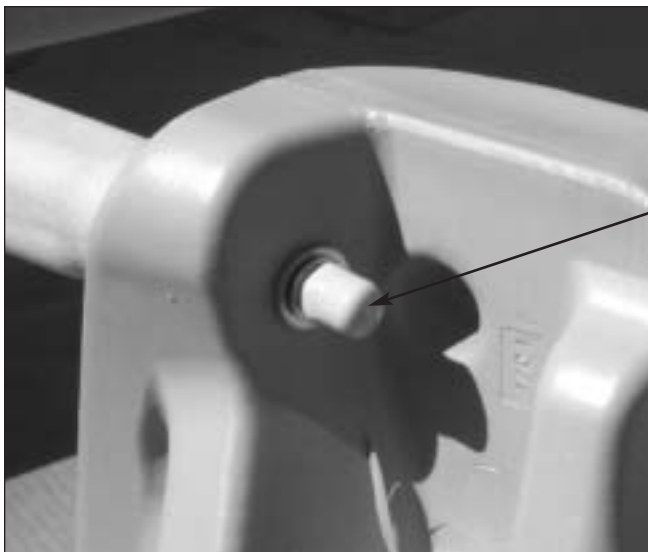

Now tighten all 6 nuts and repeat for other handrail.

Don't forget the protective rubber caps.

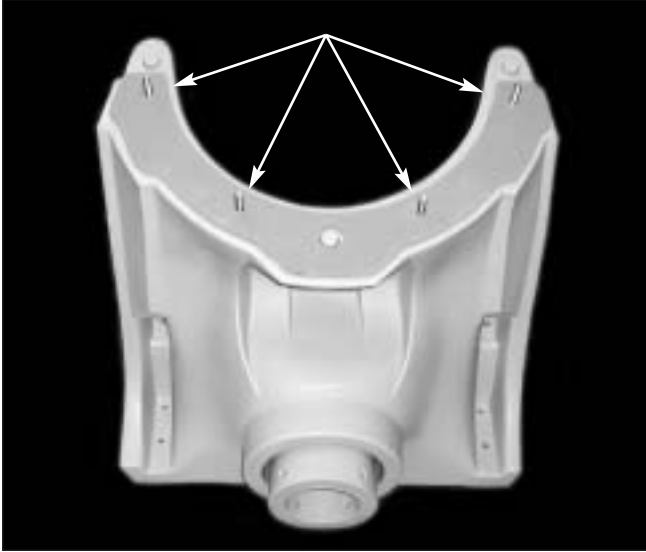

Hand tighten four 2-1/2" x 3/8" allthreads into these four locations on the flange of the top section.

Be sure to use the provided lubricant on the allthreads before inserting them into the embedded nuts.



Align the 4 allthreads in the top section with the 4 holes in the upper flume section, then shove through.



Allthreads will pass through the top flume section. Attach a flat washer, a lock washer and a nut (in that order). Hand tighten.

Do not completely tighten at this time as flume sections will need to be aligned first.

Make sure to use the provided lubricant on the allthreads before attaching the nuts.

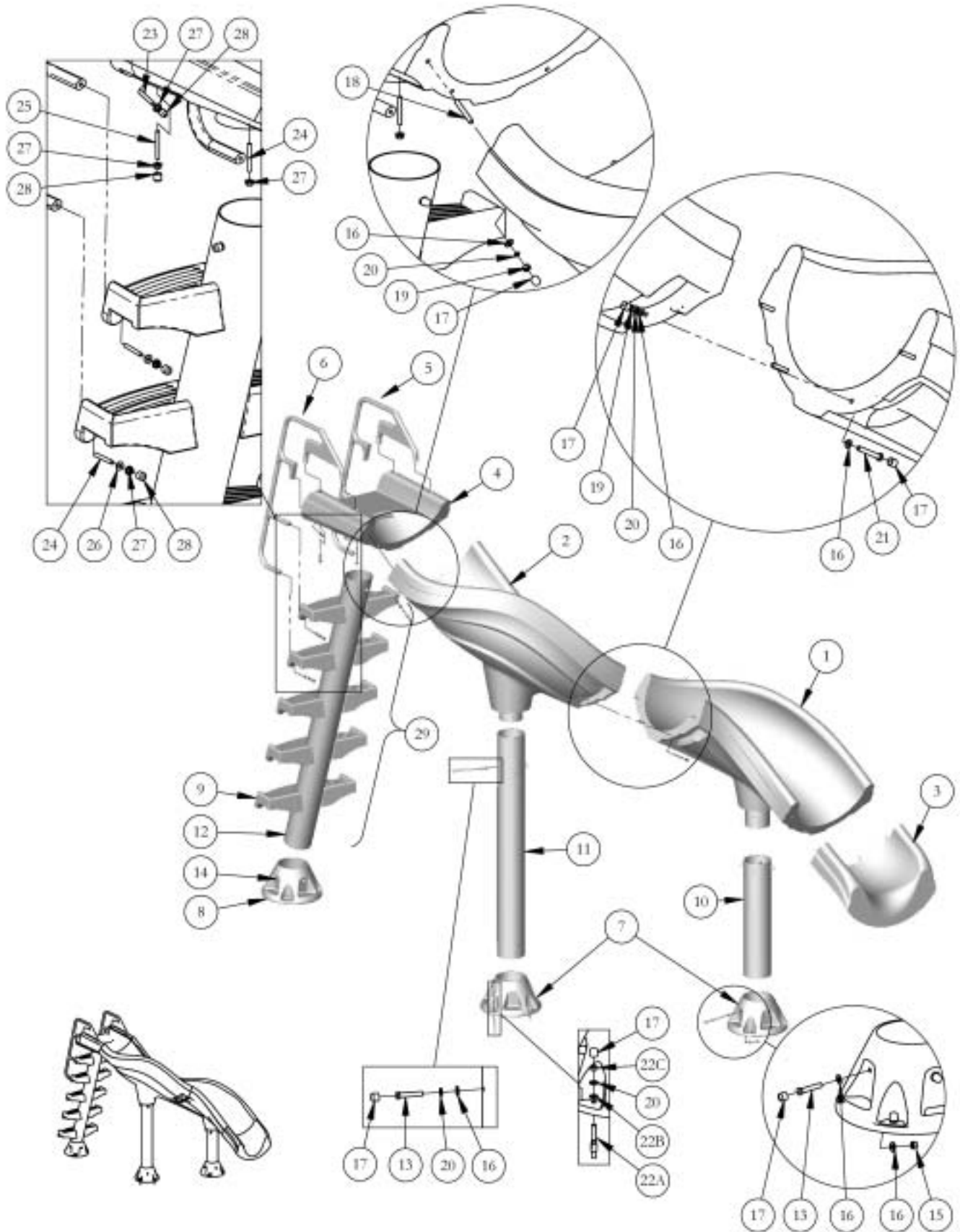

ALL CHART INFORMATION BELOW CORRESPONDS WITH THE DRAWING ON THE PREVIOUS PAGE.



DRAWING REPRESENTS THE FOLLOWING PART NUMBERS:
XS-GR

PART # XS-GR			
ITEM #	QTY.	COMPONENT	DESCRIPTION
1	1	XS-RIGHT FLUME	A & B right hand flume section (bottom position for right turn)
2	1	XS-LEFT FLUME	C & D left hand flume section (bottom position for left turn)
3	1	XS-BOTTOM	Bottom section
4	1	XS-TOP SIDE	Top side section with warning
5	1	XS-L HANDRAIL	Left handrail with X-Stream logo
6	1	XS-R HANDRAIL	Right handrail with X-Stream logo
7	2	XS-FOOT PEDESTAL	Straight foot pedestal
8	1	XS-16 FOOT PEDESTAL	16 degree foot pedestal
9	5	XS-STEP	X-Stream blow molded step
10	1	H-6 X 26	6" X 26" gray pvc pipe schedule 40
11	1	H-6 X 50.125	6" X 50.125" gray pvc pipe schedule 40
12	1	H-6 X 71.5	6" X 71.5" gray pvc pipe schedule 40
13	22	H-SS 3/8-16X2	3/8" x 2" hex head bolt ss (xs101ss-10ea, xs103ss-12ea)
14	1	H-SS 3/8 X2-1/2	3/8" x 2 1/2" hex head bolt ss (xs-101ss)
15	11	H-SS 3/8 NYLON	3/8" nylon insert nut ss (xs-101ss)
16	54	H-SS 3/8 FLT WASHER	3/8" x 1" flat washer ss (xs-101ss-22ea, xs102ss-20ea, xs103ss-12ea)
17	55	H-.562 x .390 cap	Gray protective caps (xs-101ss-11ea, xs102ss-20ea, xs103ss-12ea, xs104ss-12ea)
18	4	H-SS 3/8 x2-1/2	3/8" x 2 1/2" allthread stud ss (xs-102ss)
19	12	H-SS 3/8 F NUT	3/8" finish nut ss (xs-102ss)
20	36	H-SS 3/8 LOC WASHER	3/8" lock washers ss (xs102ss-12ea, xs103ss-12ea, (xs104ss-12ea)
21	8	H-SS 3/8 x 3 TAP	3/8" x 3" hex head tap bolt ss (xs-102ss)
22	12	H-SS 3/8 WEDGE	(A) 3/8" x 2 3/4" wedge anchor, (B) flat washer, and (C) nut (xs-104ss)
23	4	H-SS 5/16 X 2	5/16" x 2" allthread stud ss (xs-105ss)
24	6	H-SS 5/16 X 2-1/2	5/16" x 2 1/2" allthread stud ss (xs-105ss)
25	2	H-SS 5/16 X 3	5/16" x 3" allthread stud ss (xs-150ss)
26	4	H-SS 5/16 FLA WASHER	5/16" flat washer ss (xs-105ss)
27	12	H-SS 5/16-18 HEX FLANGE	5/16" hex flange nut ss (xs-105ss)
28	10	H-.463 X .310 CAP	Gray protective caps (xs-105ss)
29	1	XS-STEP ASSEMBLY	(includes 1ea-#12, 5ea-#9, 5ea-#31, 10ea-#33)
INCLUDED BUT NOT SHOWN ON EXPLODED PARTS PAGE:			
30	1	H-1 BALL VALVE	1" pvc ball valve
31	5	H-NYLON ROD 101	3/8" x 9" nylon rod (step assembly)
32	3	H-WRS GASKET	3/8" x 26 1/2" neoprene gasket (installed at factory)
33	10	H- SPA HOSE	1" pvc flex hose gray ft. (step assembly)
34	1	H-1 MALE ADAPTER	1" pvc male adapter mipt x slip (installed at factory)
35	12	H-3/8 PROPELL	3/8" propell nut (installed at factory)

NOTES:

X-Stream slide only comes in Summit Gray
 X-Stream can turn to the right or the left

SLIDE CARE & MAINTENANCE: X-Stream™ Slide**1: General Cleaning**

- Use non-abrasive soap and water when possible.
- Review cleaner's label instructions before applying to surface.
- Avoid harsh chemicals and disinfectants.

You may safely use:*

- Chlorox
- Spic & Span Powder
- Mr. Clean
- Formula 409
- Liquid Comet
- Windex
- Glass Plus
- Soft Scrub
- Calgon Bath Oil Beads

Do not use:

- Lysol Disinfectant Spray
- Dow Disinfectant Bathroom Cleaner
- Pinesol
- Whitecap
- Lestoil

2: Light scratches, abrasions, gloss, etc.

Light abrasions and scratches may be removed and original gloss fully restored using the following materials.*

- Novus Plastic Polish (Novus, Inc.)
- Mirror Glaze Professional Formula #17 (Mirror Bright Polish Co., Irvine, CA)
- Permatex Plastic Cleaner #403D (Permatex Co., Kansas City, KS)
- "J-Wax" or "Kit" Automotive Cleaner/Waxes (S.C. Johnson & Son)
- DuPont or Turtlewax "White Polish" automotive polishing compound.

Light Scratches: Very light scratches, scuff marks and haze can be hand polished with Permatex Plastic Cleaner or Gel-Glass. Follow the manufacturer's guidelines. Clean cotton cloth works best for applying the polish and buffing.*

*** These suggestions and data based on information believed to be reliable, from our raw materials manufacturers. They are offered in good faith, but without guarantee, as conditions and methods of use and procedures are beyond our control.**

LIMITED WARRANTY

Inter-fab, Inc. products are warranted to be free of material defects related to manufacturing and workmanship for a period of three (3) years from the date of retail purchase. The warranty is to the original purchaser of the product only. Products which fail or become defective during the warranty period, except as a result of improper installation, improper use or care, negligence or natural accidents (acts of God) will be repaired or replaced at Inter-Fab's option at no charge.

This warranty is a **limited warranty**. Inter-fab, Inc. disclaims any warranty of merchantability or fitness for a particular use, and Inter-fab, Inc. is not liable for consequential damages. This warranty is limited to repair, replacement, or refund of the original purchase price, whichever is less, determination at the discretion of Inter-fab, Inc. This warranty expressly does not cover any labor or reinstallation expenses.

Echoes of Nature™ products are individually handcrafted and painted by skilled artisans. Dimensional differences and color variations are normal and are not a basis for warranty coverage. Pumps sold with the Echoes of Nature™ ponds are warranted for one (1) year from the date of end user purchase.

Water Sports™ sports equipment is warranted as follows: Volleyball Poles, Basketball Post, Basketball Rim, and Basketball Backboard for one (1) year from date of end user purchase. Volleyball, Volleyball Net, Basketball, Basketball Net, and Pumps are warranted for ninety (90) days from date of end user purchase.

Zoomerang™ slide products are warranted for one (1) year from the date of retail purchase.

All Inter-fab, Inc. Warranty for replacement of product does not include labor or re-installation costs.

To enact this warranty, product owner or representative must notify Inter-Fab, Inc. (or its wholesale agent) in writing, giving a full description of the nature of the product defect or failure along with proof of purchase date and serial number of the product.

Inter-Fab, Inc. reserves the right to physically inspect damaged or defective products or components if necessary to determine the cause of the damage or defect, prior to authorizing repair or replacement of its products.



3050 S. Alvernon Way • Tucson, AZ 85713
520.790.7040 • 800.737.5386 • Fax 520.790.7127
inter-fab.com