

Pool FROG[®]
ABOVE GROUND
MINERAL SYSTEM FOR POOLS
Patented Mineral Pool Sanitizer



THE POOL FROG[®]
MINERAL RESERVOIR
MUST BE REPLACED
EVERY SIX MONTHS OR
AFTER ONE POOL
SEASON WHICHEVER
IS SHORTER.

Instruction Manual

Customer Service 800-222-0169

TABLE OF CONTENTS

POOL FROG® Introduction	3
Swimming Pool Tips	4
Start-up and Operation	5
Replacing POOL FROG® Mineral Reservoir	7
Replacing FROG BAM®	8
Replacing POOL FROG® Bac Pac	9
Troubleshooting	10
Parts List	11
Replacing Control Dial O-Rings	12
Replacing Cap O-Ring and Knob	12
Winterizing	13
Above Ground Filter Installation	14
Above Ground Base Installation	15
Warranty	16

For information on King Technology's entire product line, visit our website at www.kingtechnology.com

POOL FROG®

Welcome to easier pool care courtesy of POOL FROG®. With POOL FROG®, your pool water will look and feel better without a lot of work or a lot of chlorine. This system controls bacteria using a combination of minerals and reduced chlorine levels. There are 4 parts to the POOL FROG® System: The Above Ground POOL FROG® Cyclor, the POOL FROG® Mineral Reservoir, FROG BAM® 90-day Algae Preventative and the POOL FROG® Bac Pac.

Part I

POOL FROG® Cyclor

The water treatment center that controls the flow of water to each part of the POOL FROG® System.



For Above Ground Pools up to 25,000 gallons.

Part II

POOL FROG® Mineral Reservoir

Holds the minerals and fits inside the POOL FROG® Cyclor.

THE POOL FROG® MINERAL RESERVOIR MUST BE REPLACED EVERY SIX MONTHS OR AFTER ONE POOL SEASON WHICHEVER IS SHORTER.

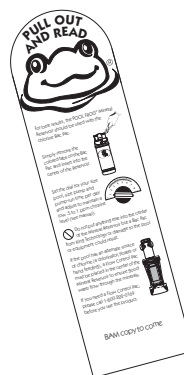

Part III

FROG BAM®

Use with the POOL FROG® System for an Algae Protection Guarantee.



Part IV

POOL FROG® Bac Pac

Chlorine support fits inside POOL FROG® Mineral Reservoir.



(POOL FROG® Mineral Reservoir sold inside POOL FROG® Cyclor and separately for replacements. POOL FROG® Bac Pac and FROG BAM® sold separately.)

Swimming Pool Tips

Start-up and Yearly Maintenance

1.

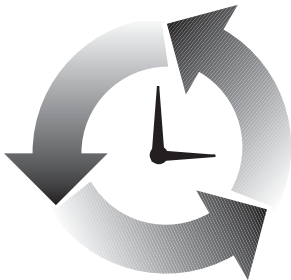

• Make sure the pool has adequate circulation. The pool water must completely circulate through the pump and filter at least 1 to 2 times per day. This usually requires 8 to 12 hours. Check with your dealer for the proper circulation time for your pool.

2.

• Before beginning with any pool care program, you must first balance your pool water. Take a water sample to your local pool professional or use a complete test kit that will test for the following important elements.

Water Balance Guidelines

pH:	7.2 — 7.8
Total Alkalinity:	60 — 120 ppm
Calcium Hardness:	150 — 400
Total Dissolved Solids:	<1500
Stabilizer:	20 — 80 ppm
Free Chlorine:	0.5 — 1.0 ppm

3.

Cu
Mg Fe

• If your fill water is high in metals, use a sequestering agent or metal out product at start-up only before using the POOL FROG® Mineral Reservoir. See your local dealer for details on using these products and always follow manufacturers directions carefully.

4.



• After your pool is up and running smoothly, continue to test your water for pH, total alkalinity and chlorine and maintain its balance by adding any necessary adjustment products (see your dealer for details).

5.

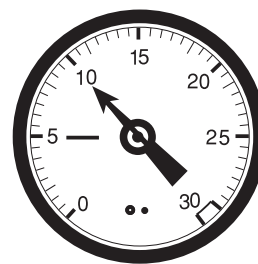

• Check the pool's filter gauge often and periodically clean filter per the manufacturer's directions. A dirty filter will slow the flow of water which could hamper proper circulation.

Start-up and Operation



- 1.**
- Add a stabilizer or conditioner to the pool at the beginning of the season if the stabilizer level is below 20 ppm. This will prevent chlorine burn off. Follow manufacturer's directions carefully.

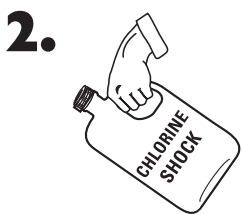

- 2.**
- Shock the pool with chlorine to rid the water of all contaminants before beginning with POOL FROG®. Follow manufacturer's directions carefully.
- THIS STEP IS VERY IMPORTANT TO START-UP. USE CHLORINE SHOCK ONLY.**



• **Do not** add shock in or near the skimmer or into the POOL FROG® Cyclor as it could damage equipment, risk potential explosion or discolor your pool surface.

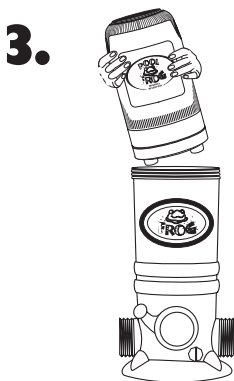

- 3.**
- Install a POOL FROG® Mineral Reservoir into the POOL FROG® Cyclor. (Follow Directions on Page 7.)

REPLACE THE POOL FROG® MINERAL RESERVOIR EVERY 6 MONTHS OR AFTER ONE POOL SEASON WHICHEVER IS SHORTER.

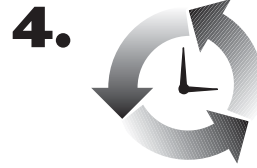

- 4.**
- Replace cap and run POOL FROG® Cyclor, with POOL FROG® Mineral Reservoir inserted, for 10 minutes on Setting 10.



- 5.**
- For an Algae Protection Guarantee insert FROG BAM® into POOL FROG® Mineral Reservoir in POOL FROG® Cyclor. (See page 8 for directions.)

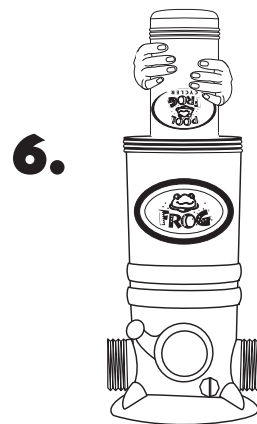

- 6.**
- When chlorine reading is down to 1.0 ppm, which may take a few days, insert POOL FROG® Bac Pac. (Follow directions on page 9.)

Start-up and Operation

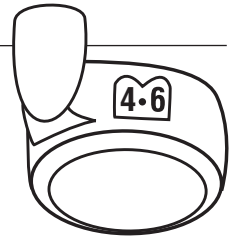

- 7.** • Set control dial by matching up the parameters of your pool on the chart below. THIS IS A STARTING POINT ONLY and may need to be adjusted to fit your individual pool needs. See #8 for directions. **IMPORTANT:** Pump run times less than 8 hours could result in under chlorination due to inadequate flow through the System.

Above Grd. POOL SIZE		8 Hour Pump Run Time				12 Hour Pump Run Time				24 Hour Pump Run Time			
		PUMP SIZE				PUMP SIZE				PUMP SIZE			
Gallons	Diameter	1/2 hp	3/4 hp	1 hp	1 1/2 hp	1/2 hp	3/4 hp	1 hp	1 1/2 hp	1/2 hp	3/4 hp	1 hp	1 1/2 hp
7,000	(18')	5	4.5	4	3.5	4.5	4	3	* 5	3.5	3	2.5	* 4
9,000	(21')	5.5	5	4.5	4	5	4.5	4	* 5.5	4	3.5	3	* 4.5
12,000	(24')	6	5.5	5	4.5	5.5	5	4.5	4	4.5	4	3.5	* 5
15,000		NR	6	5.5	5	6	5.5	5	4.5	5	4.5	4	3.5
20,000		NR	NR	6	5.5	NR	6	5.5	5	5.5	5	4.5	4

* - Bypass installation recommended.
NR - This pump size is not recommended for this size pool.

RECOMMENDED FLOW RATE: 20-60 gpm

- 8.** • For the first week test the pool water daily for free chlorine to ensure correct dial setting. Continue to test weekly throughout the season.

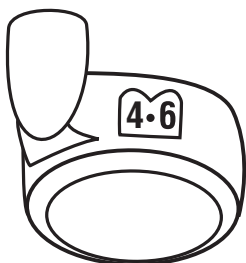

- After each testing, adjust the dial up by 1/2 increment if the free chlorine reading has dropped below 0.5 ppm or adjust down by 1/2 increment if the reading has risen above 1.0 ppm. Continue this process each day until the free chlorine reading stabilizes to at least 0.5 ppm.

- Remember to adjust dial **ONLY** by 1/2 setting per day in order to prevent over chlorination which may bleach pool surfaces.

9.



- Shock pool every two weeks or as needed to maintain water quality. Follow label directions on the shock treatment used.

If using another means of chlorine support

Follow steps 1-5 on page 5 then continue below.

6.

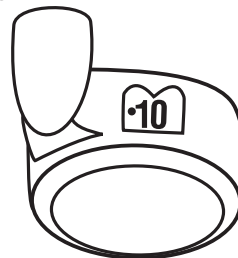

- Set dial to Setting 10. Maintain a minimum chlorine reading of 0.5 ppm with a chlorine delivery device or hand feeding.

7.



- Shock pool every two weeks or as needed to maintain water quality. Follow label directions on the shock treatment used.

Replacing a POOL FROG® Mineral Reservoir

(POOL FROG® Mineral Reservoirs MUST be Replaced Every Season)

1.

ABOVE GROUND 5100 (Order #01-12-5112)
NOW FITS THE FOLLOWING CYCLERS:
 POOL FROG Series 5100, 5200 or 6100
 Prevail Series 5770 or 5771



- Check the front of the box and back label of product to make sure you have the correct POOL FROG® Mineral Reservoir to fit your POOL FROG® Cycler.

THE POOL FROG® MINERAL RESERVOIR MUST BE REPLACED EVERY 6 MONTHS OR AFTER ONE POOL SEASON WHICHEVER IS SHORTER

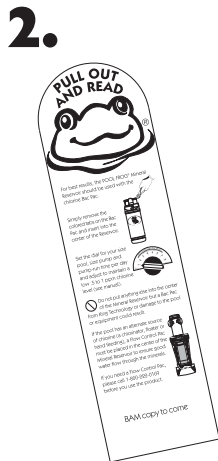

Open the box and remove the POOL FROG® Mineral Reservoir

- **IMPORTANT:** Remove and read the information card.

Please note: complete instructions for inserting a POOL FROG® Mineral Reservoir, FROG BAM® and POOL FROG® Bac Pac are included inside the POOL FROG® Mineral Reservoir box.

3.

CAUTION read carefully

- USE ONLY the factory recommended replacement POOL FROG® Mineral Reservoir, FROG BAM® and POOL FROG® Bac Pac. DO NOT USE any other Pac or bulk chemical tablets in the POOL FROG® Cycler. Use of any other product could result in damage to pool equipment or surface, unsafe pool conditions, fire or explosion. Warranty will be void if the correct POOL FROG® Mineral Reservoir, FROG BAM® and POOL FROG® Bac Pac are not used.

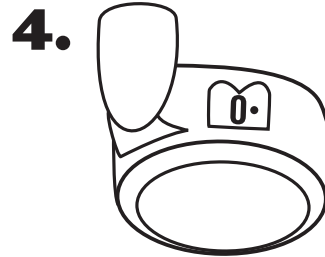

- Turn off pump and turn dial to Setting 0. This reduces the flow of water into the unit when the cap is open.



- Open cap. If using POOL FROG® Bac Pac stand back to avoid inhaling chlorine fumes.

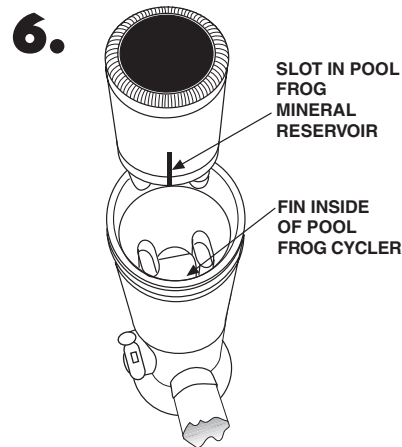

- Find slot on side of POOL FROG® Mineral Reservoir and line up with fin inside the POOL FROG® Cycler. Lower POOL FROG® Mineral Reservoir into POOL FROG® Cycler until secure.

Replace FROG BAM® for an Algae Protection Guarantee

If you are not replacing FROG BAM®, proceed to Step 15. See FROG BAM® product labeling for complete directions for use (EPA Reg. No. 53735-9).

For a preventive dose add:

- One FROG BAM® per 10,000 to 15,000 gallons.
- Two FROG BAM® per 15,000 to 30,000 gallons.



- Remove cap from FROG BAM® without removing seal.

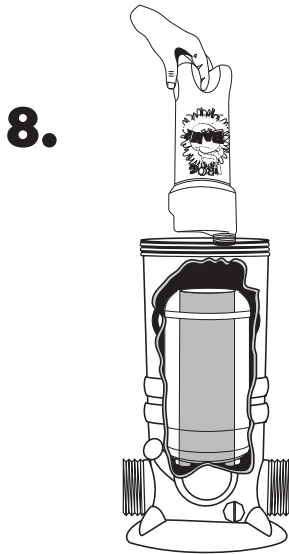

- Insert upside down into center of POOL FROG® Mineral Reservoir pushing down firmly on key inside POOL FROG® Cyclor to puncture seal on FROG BAM® bottle.



- Replace cap by hand only. **DO NOT OVER TIGHTEN.**

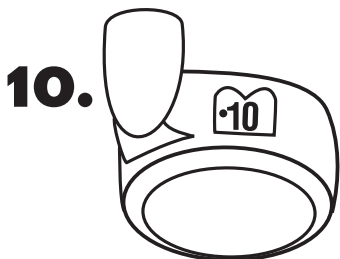

- Turn control dial on POOL FROG® Cyclor to Setting 10.

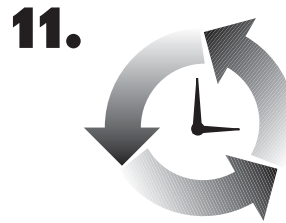

- Turn pump on for 90 minutes allowing FROG BAM® to circulate through pool.

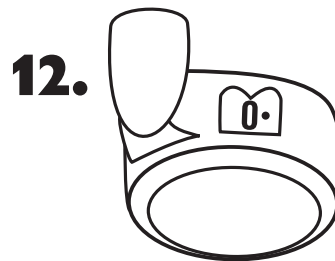

- To remove FROG BAM®, turn pump off. Turn dial to Setting 0.

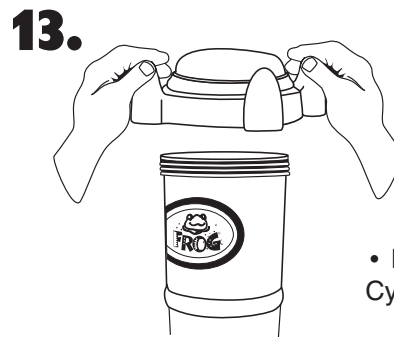

- Remove POOL FROG® Cyclor cap.



- Lift FROG BAM® up and allow any water in the container to drain through the POOL FROG® Cyclor before discarding in trash.

NOTE: If water shows more than a hint of blue inside POOL FROG® Cyclor, replace the POOL FROG® Cyclor cap, turn dial to Setting 10 and run the pump for one minute.

14a. If pool size requires additional FROG BAM®, repeat steps 7-14.

14b. When water is clear in POOL FROG® Cyclor, proceed to step 15.

Replacing POOL FROG® Bac Pac

15. Colored caps



- POOL FROG® Bac Pac recommended to assure up to 50% reduction in chlorine use*. POOL FROG® Bac Pac sold separately. (EPA Reg. No. 53735-2)

**Compared to the minimum EPA recommended chlorine level of 1.0 ppm for a stabilized swimming pool.*

16.



- Avoid sparks, open flame or smoking when handling the POOL FROG® Bac Pac.

17.



- To remove POOL FROG® Bac Pac colored caps, grab on to the lip of one cap with a pliers and pull up until cap releases. Repeat the process for the other cap.

18.

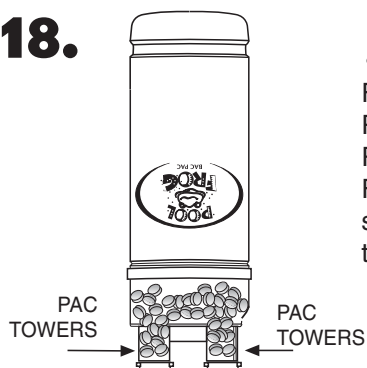

- Holding the POOL FROG® Bac Pac over the POOL FROG® Mineral Reservoir turn POOL FROG® Bac Pac over and shake slightly until chlorine tablets fall into tower areas.

19.



- Line up the small leg of the POOL FROG® Bac Pac with the small opening in the POOL FROG® Mineral Reservoir and the large leg with the large opening. Lower POOL FROG® Bac Pac into POOL FROG® Mineral Reservoir until secure.

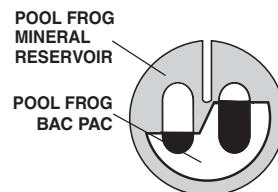

20.



- Replace cap by hand only. **DO NOT OVER TIGHTEN.**

21.



- Mark your calendar for the six month replacement of the POOL FROG® Mineral Reservoir, 90-day replacement of FROG BAM® and approximate replacement times for the POOL FROG® Bac Pac. Once wetted, the time-released mineral coating of the POOL FROG® Mineral Reservoir is effective up to 6 consecutive months or one pool season whichever is shorter. After that time, even if you hear the spent media inside, it is no longer effective and must be replaced.

Troubleshooting

For more in-depth troubleshooting, go to www.kingtechnology.com

Problem	Remedy		
<p>1. What do I do if the water looks cloudy?</p>	<p>1. Make sure your filtration system is working properly (i.e. clean filter, skimmer and pump basket).</p> <p>2. Make sure circulation time is adequate – increase pump time if not.</p>	<p>3. Make sure the pool is properly balanced (see page 4).</p> <p>4. Shock the water to eliminate build up of any organic matter.</p>	<p>5. Make sure pool has a free chlorine reading of 0.5 to 1.0 ppm.</p> <p>6. Check with your dealer for more information.</p>
<p>2. What do I do if the water turns color?</p>	<p>1. Metals in the fill water may have been oxidized. Have the pool tested. Shock the pool and clean the filter until water clarity returns.</p>	<p>2. Algae may be trying to form – shock the pool, increase circulation time if needed and clean the filter.</p>	<p>3. Check with your dealer for more information.</p>
<p>3. What do I do if algae forms in or on my pool?</p>	<p>1. Use a nonmetallic (polyquat) algaecide per the directions on the bottle and brush the sides of the pool often.</p> <p>2. Clean the filter and shock the pool with chlorine daily until water clarity returns.</p>	<p>3. If you are in an area of the country that struggles with algae growth, see your dealer regarding a 90-day Algae Protection Guarantee using FROG BAM®. See product hang tag for guarantee details.</p>	<p>4. Check with your dealer for more information.</p>
<p>4. What do I do if I am under chlorinating with the POOL FROG® Bac Pac?</p>	<p>1. If you are unable to maintain 0.5 to 1.0 ppm, first make sure there are chlorine tablets in the tower areas of the POOL FROG® Bac Pac and it is installed properly. If a correction was made, test the water in 24 hours.</p> <p>2. If still low, turn the dial up one setting and test the water again in 24 hours. Continue</p>	<p>raising the setting by one increment each day until the proper reading is achieved.</p> <p>3. Shock the pool if the reading has been lower than 0.5 ppm for more than one day.</p> <p>4. Bleed air by unscrewing the knob in the back of the POOL FROG® Cyclor while the pump is running.</p>	<p>5. Increase pump time if possible.</p> <p>6. Contact your dealer to have your back pressure tested to ensure it is between 3 & 8 psi.</p> <p>7. Contact King Technology's Customer Service Department at 800-222-0169.</p>
<p>5. What do I do if I am over chlorinating with the POOL FROG® Bac Pac?</p>	<p>1. If the chlorine reading is over 3.0 ppm, remove the POOL FROG® Bac Pac from the POOL FROG® Mineral Reservoir and test the water daily until the reading is down to 1.0 ppm.</p> <p>2. Reinsert the POOL FROG® Bac Pac, lower the dial one setting and test the water again in 24 hours.</p>	<p>If the reading has risen, lower the dial one setting again. Continue this process until proper reading is achieved.</p> <p>3. If over-chlorinating at the lowest possible setting, consider decreasing the circulation time. Depending on your pump size,</p>	<p>you may be circulating the water more than is necessary which results in more chlorine than is necessary.</p> <p>4. Contact King Technology's Customer Service Department at 800-222-0169.</p>

Parts List Model 6100/6500

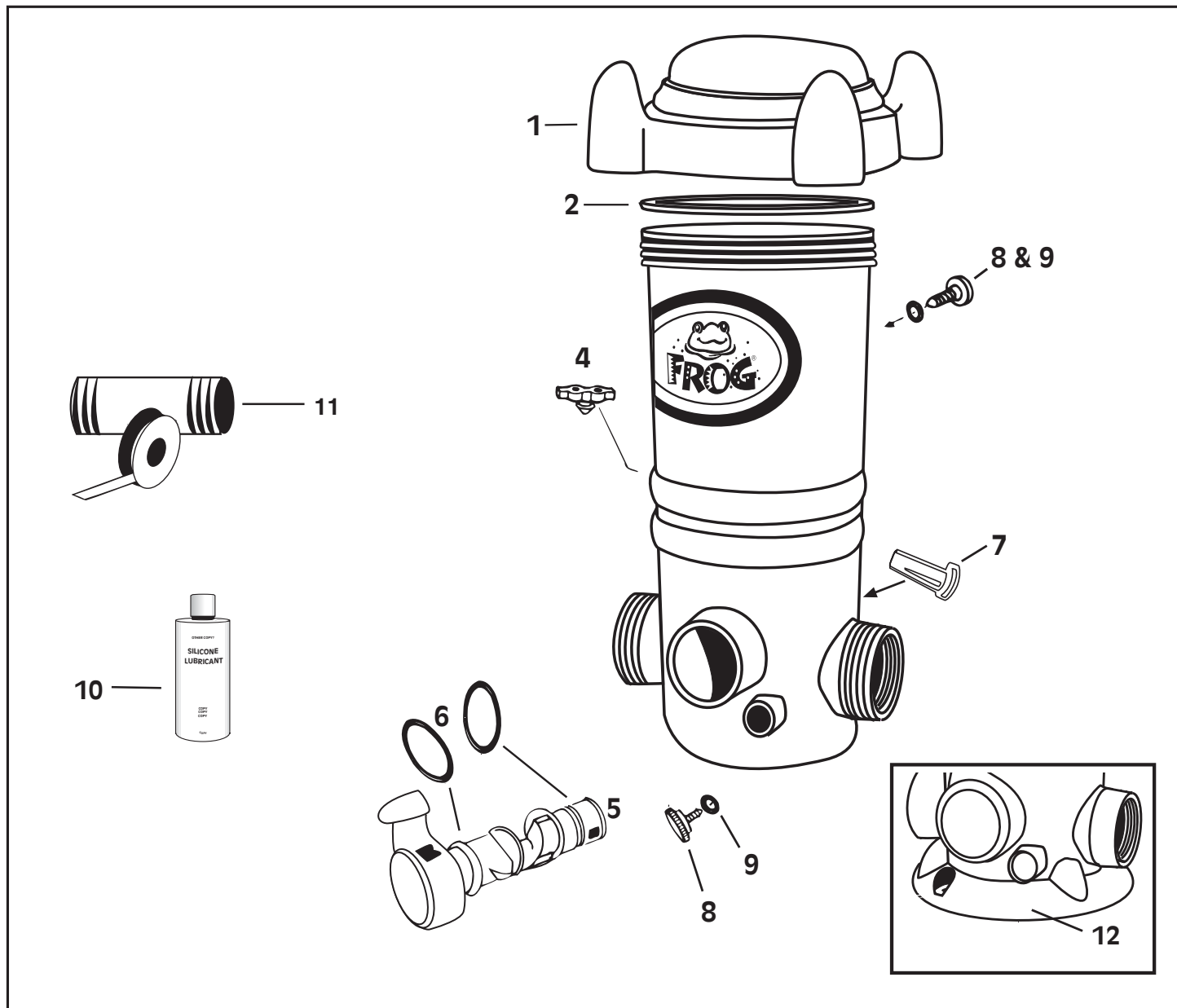

CYCLER DIAGRAM/PARTS LIST • Model 6100 or 6500

REF. #	PART NO.	DESCRIPTION	QTY. REQ.
1 & 2	01-22-1418	Cap w/O-Ring	1
2	01-22-1920	Cap O-Ring	1
3	N/A	Body	1
4	01-22-9480	Pressure Relief Valve	1
5, 6, 7	01-22-1448	Control Dial with O-Rings	1
6	01-22-1450	Control Dial O-Ring Set	1
7	N/A	Control Dial Locking Pin	1
8 & 9	01-22-9941	Knob with O-Ring	2
10	01-22-9970	Silicone Lubricant	1
11	01-22-1710	Nipple Kit	1
12	01-22-1480	Mounting Base	1

POOL FROG® Cyclor Maintenance

Replacing the Control Dial O-Rings

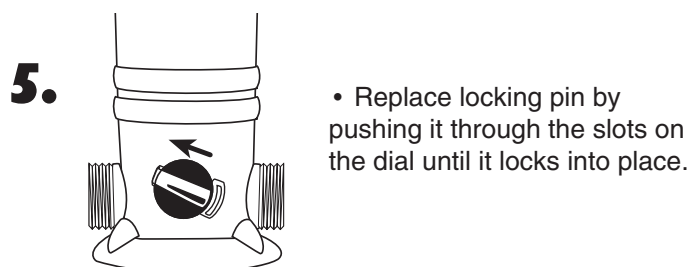
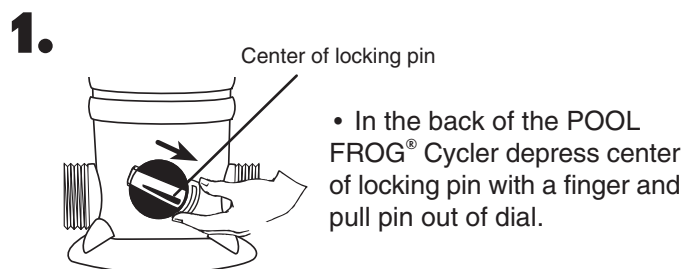

Replacing Cap O-Ring

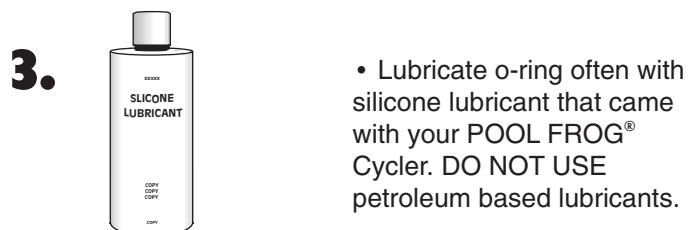
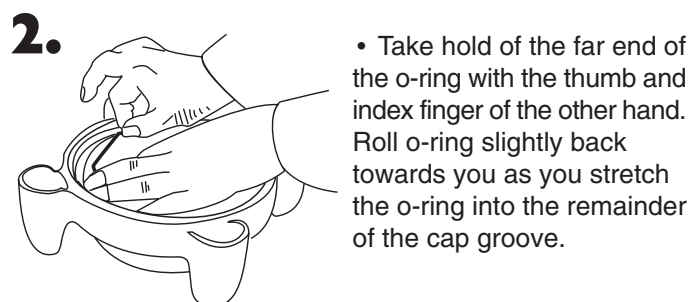
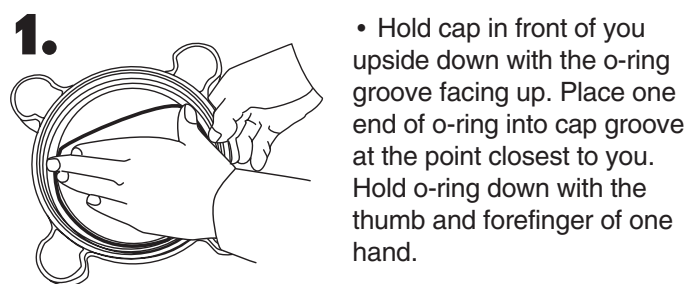

Replacing knob

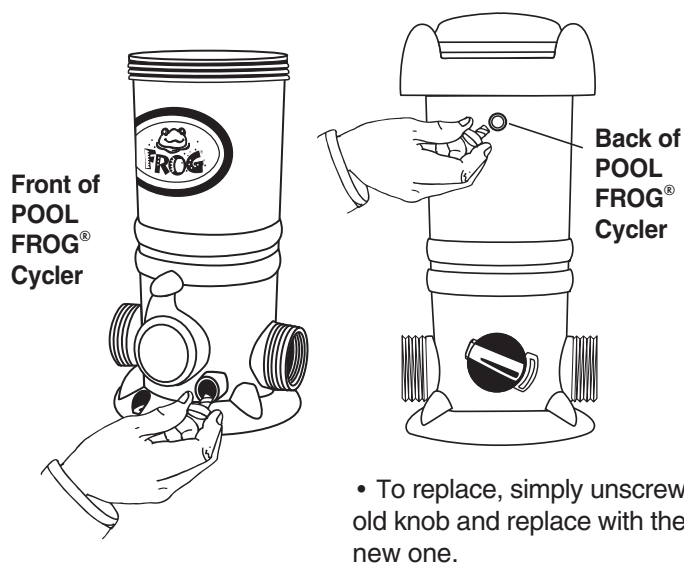

Winterizing

1.

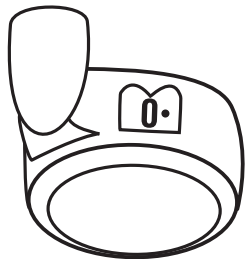

- Turn pump off and turn dial to Setting 0.

2.



- Remove cap.

3.

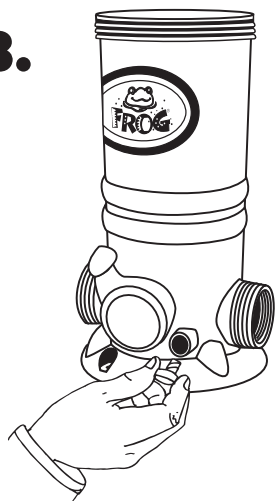

- Unscrew knob from the front of POOL FROG® Cycler. Allow all water to drain.

4.



- If POOL FROG® Bac Pac still contains chlorine wrap in plastic bag and store in shed or garage away from children and pets. Make sure POOL FROG® Bac Pac is away from open flame or anything metal.

5.



- Remove the POOL FROG® Mineral Reservoir and discard in trash. Even if you hear spent minerals inside, it is no longer effective.

6.



- Replace the cap and knob loosely.

Above Ground Filter Installation

TOOLS NEEDED

Screwdriver



Pipe Wrench

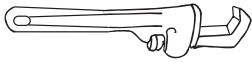

INCLUDED WITH POOL FROG® CYCLER

Tape



One 6" x 1 1/2" TBE PVC Nipple



MATERIALS NEEDED

One Hose Adapter
1 1/2" x 1 1/2" x 1 1/4"

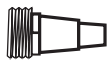

One Section of
1 1/2" Flex Hose
(provided with filter)

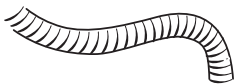

One
Hose
Clamp



RECOMMENDED

Corrosion Resistant
Check Valve

1. Apply tape to each threaded end of nipple.

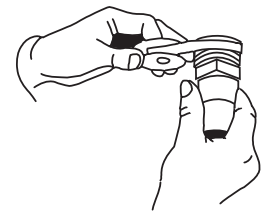
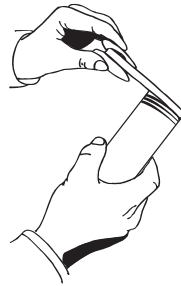

4. Apply tape to threaded end of hose adapter.

2. Screw one end of nipple into the filter return.

Tighten turning 1 to 2 revolutions with wrench. **DO NOT OVER TIGHTEN.**

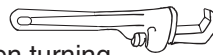

5. Screw adapter into the other side of POOL FROG® Cyclers.

Tighten turning 1 to 2 revolutions with wrench. **DO NOT OVER TIGHTEN.**

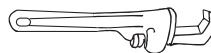

3. Screw either side of POOL FROG® Cyclers on to open nipple end until upright and secure.

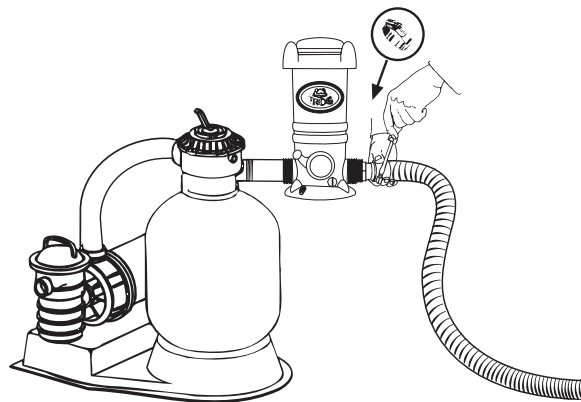
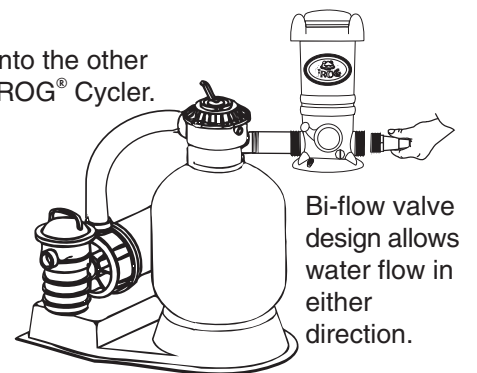
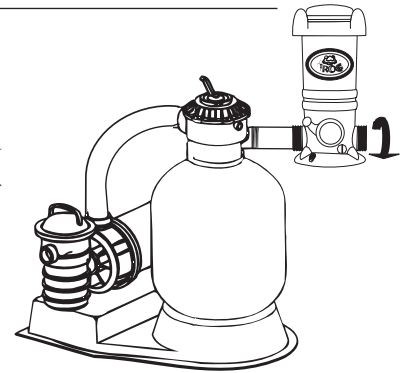

6. Attach return section of hose to the adapter with clamp. Tighten clamp with screwdriver.

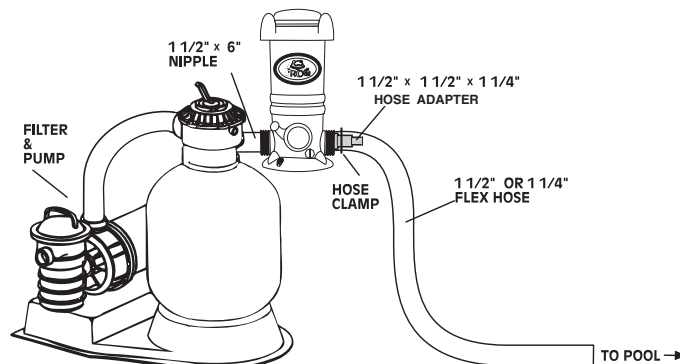

7. If using a POOL FROG® Bac Pac, installing a corrosion resistant check valve is recommended.

TOOLS NEEDED



Screwdriver

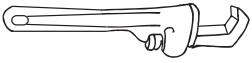

Pipe Wrench

MATERIALS NEEDED

Tape



Two Hose Adapters
1 1/2" x 1 1/2" x 1 1/4"

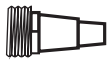

Two Sections
of 1 1/2" Flex Hose
(one provided with filter)

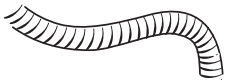

Two
Hose
Clamps



RECOMMENDED

Corrosive Resistant
Check Valve

#10 x 1 1/4" Phillips
Pan Head Screws with
Washers



OPTION



1 1/2" Male Adaptor
(slip x MPT)

When installing with
hard PVC pipe, use a
male adaptor on the
inside port threads.

Above Ground, Base Installation

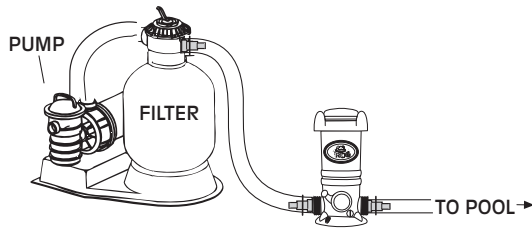

The POOL FROG® Cyclizer should always be installed between the filter and pool (or between heater and pool if applicable).

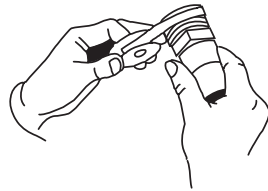

1. Apply tape to the threaded end of both hose adapters.

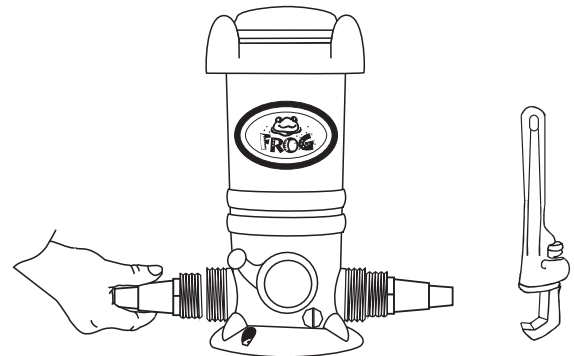

2. Screw adapters into each end of POOL FROG® Cyclizer. Tighten turning 1 to 2 revolutions with wrench. **DO NOT OVER TIGHTEN.**

3. Attach the filter section of flex hose to one hose adapter and the return section of flex hose to the other hose adapter with clamps and tighten with screwdriver.

Bi-flow valve design allows water flow in either direction.

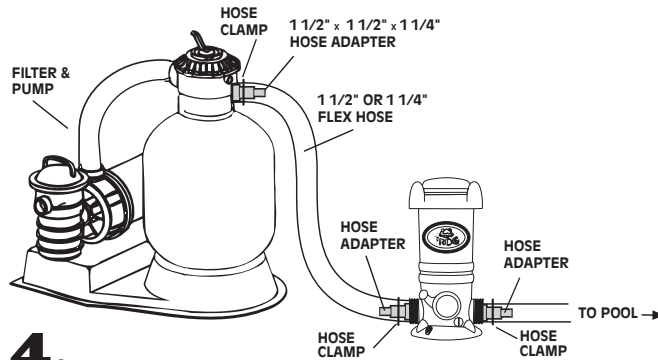
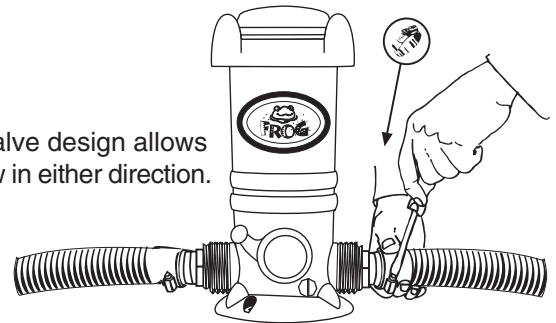

4. If using a POOL FROG® Bac Pac installing a corrosion resistant check valve is recommended.

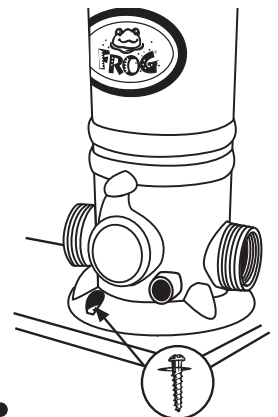

5. For better stability, POOL FROG® Cyclizer may be mounted on a base using Phillips pan head screws. One in front and two in back.

POOL FROG® Cyclor Two-Year Limited Warranty

King Technology, Inc. warrants to the original purchaser this unit will be free from any defects in workmanship and/or material, for a period of two (2) years from the date of original purchase. This warranty covers body, cap and control dial, but specifically excludes o-rings. King Technology at its option may replace any defective parts or the entire unit without charge after it is determined what is needed to correct any deficiency. Replacement parts with the exception of o-rings are warranted for the remainder of the original warranty. To extend the limited warranty from two years to ten years, simply complete the warranty card that came with your unit and return it to King Technology within 30 days of purchase and installation.

1. To obtain warranty service, you must deliver the unit to King Technology or its nearest authorized dealer. Shipping expenses are the purchaser's responsibility. The name of the nearest authorized dealer can be obtained by writing or calling King Technology at the address and telephone number provided below. Proof of purchase is required when requesting warranty service. Purchaser must present the sales receipt or other documentation verifying proof of purchase.

2. This warranty does not cover defects caused by: Modification, alteration, repair or service of the unit contrary to the accompanying instructions; physical abuse to or misuse of the product or operation or installation in a manner contrary to the accompanying instructions. This warranty also excludes all costs arising from the installation, adjustment, removal or replacement of defective units or parts. This warranty also excludes any and all claims arising out of the chemicals used in the product or their characteristics.

3. CAUTION - Read carefully – Failure to follow these instructions will void the warranty. Do not add shock in or near skimmer.

A. This unit is not designed for shock treatment of pools. See your pool dealer or distributor for further information concerning shock treatments.

B. Control dial settings in excess of the recommended setting levels for trichlor can result in excess sanitizers being discharged into the pool. This can result in bleaching or discoloration of areas around the pool inlet or in some cases bleaching or discoloration of the entire pool liner or paint.

C. Excess trichlor in the pool can create health hazards to bathers. Consult each chemical manufacturer's warnings and cautions for specifics.

D. Misuse or failure to use the proper POOL FROG® Mineral Reservoir and POOL FROG® Bac Pac may cause damage to equipment or personal injury. This warranty will be null and void, if this unit is not used with the recommended POOL FROG® Mineral Reservoir and POOL FROG® Bac Pac.

4. This warranty is the exclusive warranty for the POOL FROG® Cyclor. This warranty is not transferable. **KING TECHNOLOGY MAKES NO REPRESENTATION OR WARRANTY OF ANY KIND, EXPRESS OR IMPLIED, AS TO MERCHANTABILITY, FITNESS FOR A PARTICULAR PURPOSE OR ANY OTHER MATTER CONCERNING THE POOL FROG® CYCLOR.** Any express warranty not provided herein, and any remedy for breach of contract but which for this provision might arise by implication or operation of law is hereby excluded and disclaimed. **THE EXCLUSIVE REMEDY FOR ANY CUSTOMER IS THE REPAIR OR REPLACEMENT OF THE UNIT, AND THE RECOVERY OF DAMAGES WILL NOT EXCEED THE PURCHASE PRICE OF THE UNIT. IN NO EVENT WILL KING TECHNOLOGY BE LIABLE FOR ANY INCIDENTAL, CONSEQUENTIAL, SPECIAL OR PUNITIVE DAMAGES FROM ANY CAUSE.**

5. Under no circumstance shall King Technology be liable to purchaser or any other person for any damage or loss incurred because of any chemicals used in the product or their physical characteristics, or interruption of service of the product, or any resulting special, incidental or consequential damages or losses. Some states do not allow the exclusion or limitation of incidental consequential damages, so the above limitation or exclusion may not apply to you.



The Association of
Pool & Spa Professionals®

Made in U.S.A.

Covered by one or more of the following U.S. Patent Numbers: 4,662,387; 5,076,315; 5,218,983; 6,190,547; 6,210,566; 6,217,892; 6,383,507; 6,551,609; 6,652,871; 6,544,415 and other U.S. and Foreign Patents Pending.

Manufactured by: **KING TECHNOLOGY, INC.**
530 11th Avenue South, Hopkins, MN 55343 U.S.A.
952-933-6118 • 800-222-0169 • FAX 952-933-2206 www.kingtechnology.com

20-48-0151E
553100543R2