

FAFCO

Solar Bear

**ABOVE GROUND POOL
SOLAR HEATING SYSTEM**



INSTALLATION MANUAL



FAFCO Solar Bear

Above Ground Pool Solar Heating System

Thank you for choosing the Solar Bear above ground pool solar heating system. When used properly, the Solar Bear will provide you with years of free warmth for your pool. Read the following instructions completely before installing your system.

Table of Contents

Solar Bear Plus.....	1-3
Solar Bear Economy.....	4-6
Solar Bear Junior.....	7-9
Mounting and Repairing.....	10
Troubleshooting.....	11

For Your Information

How well does Solar heating work?

An Above Ground Pool Solar Heating System sized and installed properly, will raise pool temperatures 10°-15° during the season. Solar will not work as well when it is cloudy or rainy (you most likely won't be swimming during those times). After one or two warm days, your water will be back up to a comfortable temperature.

What additional parts will I need to complete my installation?

You will need the correct amount of hose or pipe to connect our system with your pool equipment. For rooftop installations, it is important to purchase a roof mounting kit. If you are using more than one panel, you will need to purchase a panel add on kit. You will find the roof mounting kit, panel add-on kit, and if needed, a panel repair kit, at your local pool dealer.

Will I need a special pump?

You shouldn't have any problems using your existing pump if your pool pump is in good working condition. A one HP pump will handle installations up to 30 feet away from the pool equipment and one story high. You are getting enough flow if the panel is cool to the touch on a hot day.

What should I do if I have more questions?

For further assistance please check out our website at www.fafco.com or call FAFCO Customer Service at 1-800-994-7652.

F A F C O Solar Bear Plus System

Above Ground Pool Solar Heating System

Your system is supplied with a pre-plumbed 4'x20' solar collector, 1-½" hose fittings, and a 1-½" hose. If your pool uses a different size, see your pool store for other hose sizes, hose clamps, or adapters. The barbs on your Solar Bear system accept 1-½" hose.

STEP 1: INSTALLATION

Lay the box containing the solar system on its side near where you will be making the plumbing connections. Make sure you choose a spot where the panel will be in the sun as much as possible during the day. Afternoon sun is better than morning sun. You will need an area approximately 20 ft x 4 ft in which to lay out the collector.

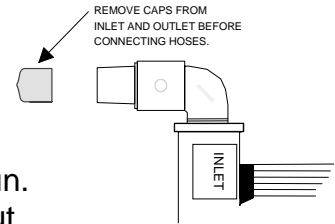

1. Remove the solar heater by opening box from the end and sliding panel out. Position the rolled up panel so it will unroll into the area you have chosen for the collector.



Remove and discard the caps that cover the inlet and outlet plumbing on your Solar Bear panel. Keep the strap on and the panel rolled up until instructed to unroll it.

2. Turn off your pool pump. Block the inlet and outlet of your pool by using plugs given to you by your pool manufacturer, or a suitable alternative.

Unhook the hose from the pool INLET (where the hose connects to your pool after coming from the filter).

BEFORE ADDING SOLAR PANEL

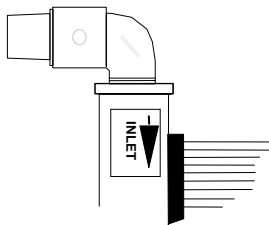
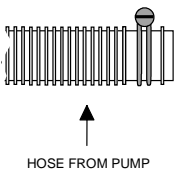
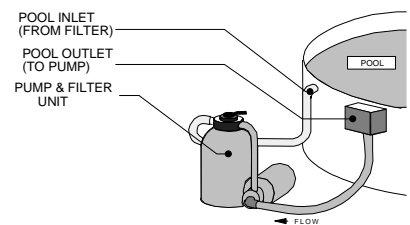

With the clamp in place, push and twist the hose onto the hose barb labeled 'inlet' on your Solar Bear solar heater. Tighten clamp. *NOTE: You may need to warm the end of the hose to make it more pliable. This can be accomplished by placing it in hot water for several seconds.*

- Place the loose hose clamp over the new hose (supplied). Push and twist the new hose onto the solar heater's 'outlet' hose barb. Secure the clamp firmly, but do not over tighten.

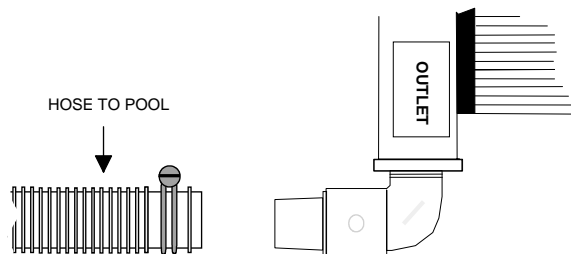

AFTER ADDING SOLAR PANEL

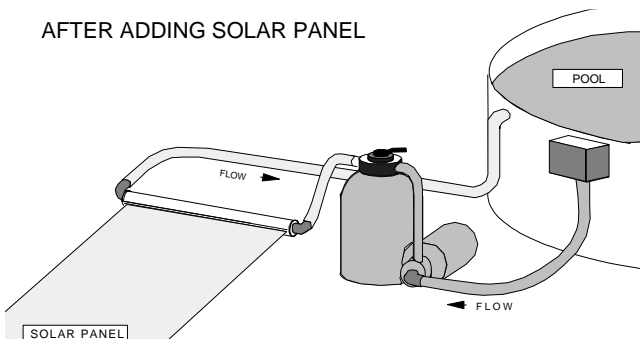

Attach the other end of the 'outlet' hose onto the pool inlet (the place that you removed the first hose from). If you already have another type of heater (like a gas heater) on your pool, plumb in the solar heater upstream (before) the other heater.

- Unblock the inlet and outlet of your pool. Be sure the red handle in the middle of the end-pipe of your solar collector is in line with the end-pipe ('solar off' position) prior to starting the system. Turn your pump on and check the hose clamps and plumbing for leaks. If there's a leak, you may have to loosen the clamp, then push the hose further up onto the barb. Then tighten the hose clamps or couplers again. After the pump is on and has run for about 5 minutes, slowly turn the red handle across the end-pipe ('solar on' position). The air that was in the panel will bubble out into your pool for a few minutes; this is normal.

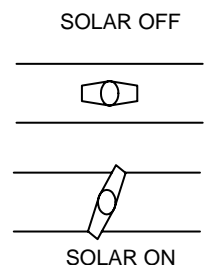

When the bubbles in the pool stop, turn the pump off and peel off the strap (be sure to save it for future use). Now that the panel is free, gently unroll it all the way. Once it is pulled flat, it may try to roll back up when released. If this happens, place a smooth object of no more than 15 pounds on each end of the panel to hold it flat. After 30 minutes or so in the sun the panel will stay flat by itself.

NOTE: After 15 minutes, feel the surface of the solar panel. It should be hot. Turn on the system, wait 10 minutes, and again feel the panel surface. It now should be much cooler. *The difference in temperature is heating your pool.*

STEP 2: HEATING YOUR POOL

WARNING: If the panel is full of water and has been sitting in the sun without the pump running, the water can get very hot. Hot water can cause burns, so be sure that everyone is away from the pool inlet each time the solar is turned on.

When the solar system is running efficiently, the panel will be cool to the touch. The sun's heat will be carried into your pool immediately. For best results, turn on

your Solar Bear whenever the panel is in the sun. Turn the solar and/or the pump off at night, when it's cloudy, or when it's raining to prevent cooling of the pool. If your pool system has a timer, set it to operate from 9 a.m. until 5 p.m. This is the best solar heating period.

Using a solar blanket in addition to the solar panel will hold the warmth in the pool and help it heat more quickly. It is particularly important to use the blanket at night or when it's windy.

If your pool becomes too warm during the season, turn the pump and solar on at night to help *cool* the pool.

COOL IS HOT !

When your solar panel is working properly it will feel cool to the touch. This is because the solar energy (heat) is carried away immediately into your pool.

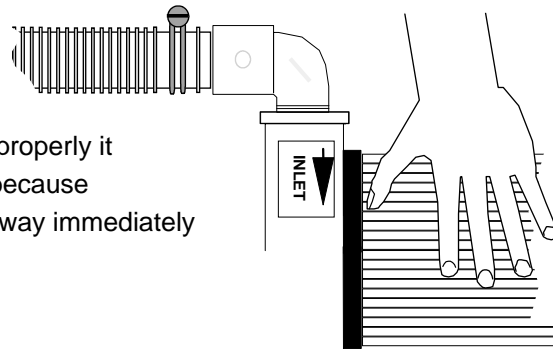

STEP 3: WINTERIZING

The panel must be drained and stored before the first frost. If water is allowed to freeze in the panel it may damage it. This damage is not covered by your warranty.

1. Turn off your pool pump.
2. Place the plugs given to you with your pool in the inlet and outlet of the pool.
3. Disconnect both of the hoses from the hose barbs on the solar heater. Disconnect the hose that came with your solar system from the pool inlet. Connect the hose from the pump to the inlet on the pool.
4. Remove the plugs from the inlet and outlet of the pool and check the hose clamps you just tightened for leaks.
5. Unscrew the white drain plug that's located on the panel end opposite the inlet and outlet.
6. Roll the panel and secure using the black carrying strap. Tilt panel until water no longer comes out. *Replace drain plug*, and store the panel and plumbing in the garage or a shed until next spring.

FAFCO Solar Bear Economy System

Above Ground Pool Solar Heating System

Your system is supplied with a pre-plumbed 4' X 20' solar collector and 1-½" hose fittings. See your pool store for 1-½" hoses and clamps.

STEP 1: INSTALLATION

Lay the box containing the solar system on its side near where you will be making the plumbing connections. Make sure you choose a spot where the panel will be in the sun as much as possible during the day. Afternoon sun is better than morning sun. You will need an area approximately 20 ft x 4 ft in which to lay out the collector.

1. Remove the solar heater by opening box from the end, and sliding panel out. Position the rolled up panel so it will unroll into the area you have chosen for the collector.

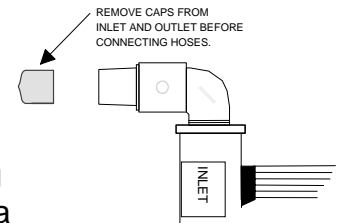

! *Remove and discard the caps that cover the inlet and outlet plumbing on your Solar Bear panel. Keep the strap on and the panel rolled up until instructed to unroll it.*

2. Turn off your pool pump. Block the inlet and outlet of your pool by using plugs given to you by your pool manufacturer, or a suitable alternative.

BEFORE ADDING SOLAR PANEL

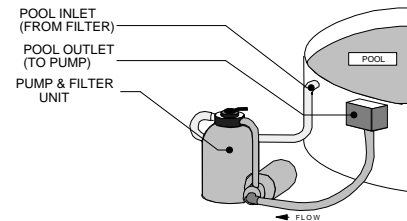

Unhook the hose from the pool inlet (where the hose connects to your pool after coming from the filter).

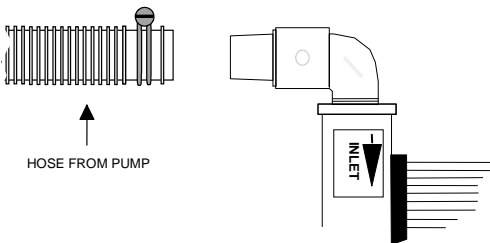

With the clamp in place, push and twist the hose onto the hose barb labeled 'inlet' on your Solar Bear solar heater. Tighten clamp. *NOTE: You may need to warm the end of the hose to make it more pliable. This can be accomplished by placing it in hot water for several seconds.*

- Place the loose hose clamp over the new hose. Push and twist the new hose onto the solar heater's 'outlet' hose barb. Secure the clamp firmly, but do not over tighten.

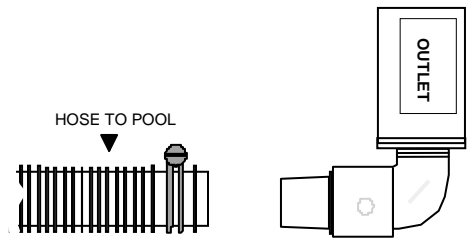

AFTER ADDING SOLAR PANEL

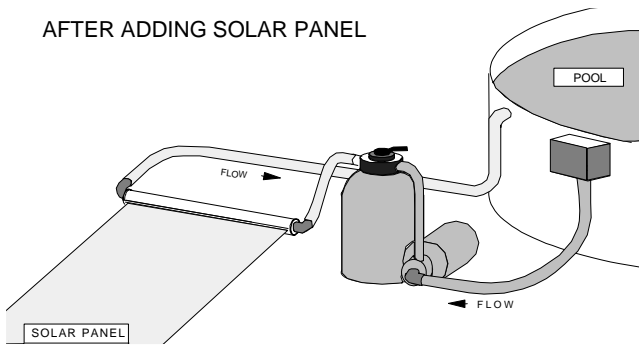

Attach the other end of the 'outlet' hose onto the pool inlet (the place that you removed the first hose from). If you already have another type of heater (like a gas heater) on your pool, plumb in the solar heater upstream (before) the other heater.

- Unblock the inlet and outlet of your pool. Be sure the red handle in the middle of the end-pipe of your solar collector is in line with the end-pipe (solar off position) prior to starting the system. Turn your pump on and check the hose clamps and plumbing for leaks. If there's a leak, you may have to loosen the clamp, then push the hose further up onto the barb. Then tighten the hose clamps or couplers again. After the pump is on and has run for about 5 minutes, slowly turn the red handle across the end-pipe ('Solar On' position). Watch the pressure gauge on your filter. When it has increased 5-7 psi you have achieved optimum flow through the panel and *should stop turning the handle*. In most cases the handle should never be turned completely across the pipe. The air that was in the panel will bubble out into your pool for a few minutes--this is normal.

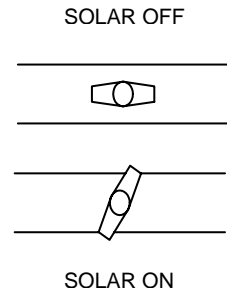

When the bubbles in the pool stop, turn the pump off and peel off the strap (be sure to save it for future use). Now that the panel is free, gently unroll it all the way. Once it is pulled flat, it may try to roll back up when released. If this happens, place a smooth object of no more than 15 pounds on each end of the panel to hold it flat. After 30 minutes or so in the sun the panel will stay flat by itself.

NOTE: After 15 minutes, feel the surface of the solar panel. It should be hot. Turn on the system, wait 10 minutes, and again feel the panel surface. It now should be much cooler. *The difference in temperature is heating your pool.*

STEP 2: HEATING YOUR POOL

WARNING: If the panel is full of water and has been sitting in the sun without the pump running, the water can get very hot. Hot water can cause

burns, so be sure that everyone is away from the pool inlet each time the solar is turned on.

When the solar system is running efficiently, the panel will be cool to the touch. The sun's heat will be carried into your pool immediately. For best results, turn on your Solar Bear whenever the panel is in the sun. Turn the solar and/or the pump off at night, when it's cloudy, or when it's raining to prevent cooling of the pool. If your pool system has a timer, set it to operate from 9 a.m. until 5 p.m. This is the best solar heating period. Using a solar blanket in addition to the solar panel will hold the warmth in the pool and help it heat more quickly. It is particularly important to use the blanket at night or when it's windy.

If your pool becomes too warm during the season, turn the pump and solar on at night to help *cool* the pool.

COOL IS HOT !

When your solar panel is working properly it will feel cool to the touch. This is because the solar energy (heat) is carried away immediately into your pool.

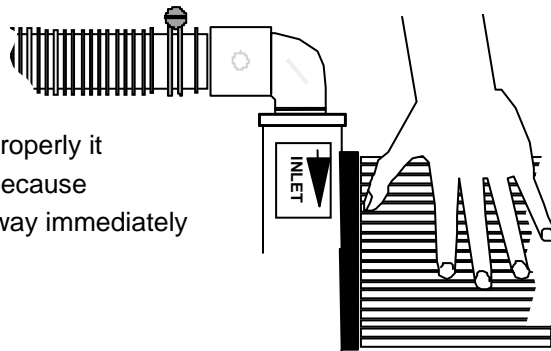

STEP 3: WINTERIZING

The panel must be drained and stored before the first frost. If water is allowed to freeze in the panel it may damage it. This damage is not covered by your warranty.

1. Turn off your pool pump.
2. Place the plugs given to you with your pool in the inlet and outlet of the pool.
3. Disconnect both of the hoses from the hose barbs on the solar heater. Disconnect the hose that came with your solar system from the pool inlet. Connect the hose from the pump to the inlet on the pool.
4. Remove the plugs from the inlet and outlet of the pool and check the hose clamps you just tightened for leaks.
5. Unscrew the white drain plug that's located on the panel end opposite the inlet and outlet.
6. Roll the panel and secure using the black carrying strap. Tilt panel until water no longer comes out. *Replace drain plug*, and store the panel and plumbing in the garage or a shed until next spring.

F A F C O Solar Bear Junior Disc System

Above Ground Pool Solar Heating System

Your system is supplied with a pre-plumbed 4' X 10' solar collector and 1-½" hose fittings. See your pool store for 1-½" hoses and clamps.

STEP 1: INSTALLATION

Lay the box containing the solar system on its side near where you will be making the plumbing connections. Make sure you choose a spot where the panel will be in the sun as much as possible during the day. Afternoon sun is better than morning sun. You will need an area approximately 4 ft x 10 ft in which to lay out the collector.

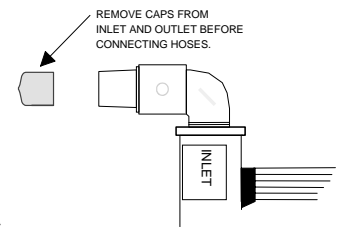

1. Remove the solar heater by opening box from the end, and sliding panel out. Position the rolled up panel so it will unroll into the area you have chosen for the collector.

! **Remove and discard the caps that cover the inlet and outlet plumbing on your Solar Bear panel. Keep the strap on and the panel rolled up until instructed to unroll it.**

2. Turn off your pool pump. Block the inlet and outlet of your pool by using plugs given to you by your pool manufacturer, or a suitable alternative.

BEFORE ADDING SOLAR PANEL

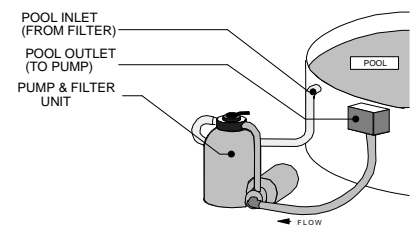

Unhook the hose from the pool inlet (where the hose connects to your pool after coming from the filter).

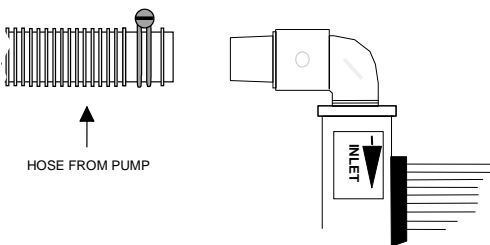

With the clamp in place, push and twist the hose onto the hose barb labeled 'inlet' on your Solar Bear solar heater. Tighten clamp. *NOTE: You may need to warm the end of the hose to make it more pliable. This can be accomplished by placing it in hot water for several seconds.*

3. Place the loose hose clamp over the new hose. Push and twist the new hose onto the solar heater's 'outlet' hose barb. Secure the clamp firmly, but do not over tighten.

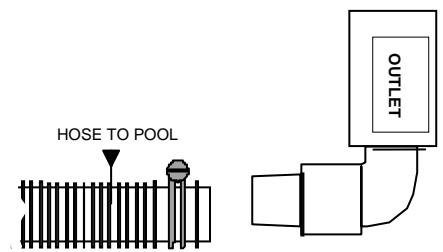

AFTER ADDING SOLAR PANEL

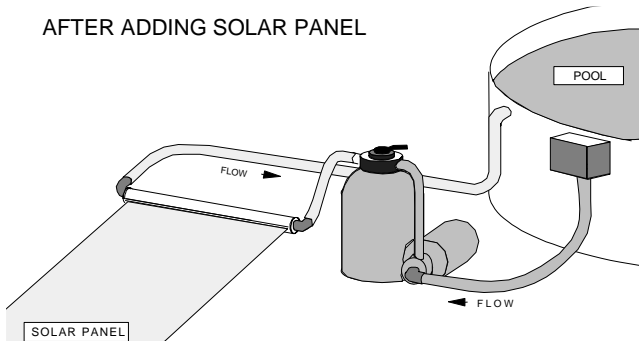

Attach the other end of the 'outlet' hose onto the pool inlet (the place that you removed the first hose from). If you already have another type of heater (like a gas heater) on your pool, plumb in the solar heater upstream (before) the other heater.

4. Unblock the inlet and outlet of your pool. Turn your pump on and check the hose clamps and plumbing for leaks. If there's a leak, you may have to loosen the clamp and push the hose further up onto the barb. Then tighten the hose clamps or couplers again. The air that was in the panel will bubble out into your pool for a few minutes, this is normal.

When the bubbles in the pool stop, turn the pump off and remove the strap (be sure to save it for future use). Now that the panel is free, gently unroll it all the way. Once it is pulled flat, it may try to roll back up when released. If this happens, place a smooth object of no more than 15 pounds on each end of the panel to hold it flat. After 30 minutes or so in the sun the panel will stay flat by itself.

NOTE: After 15 minutes, feel the surface of the solar panel. It should be hot. Turn on the system, wait 10 minutes, and again feel the panel surface. It now should be much cooler. *The difference in temperature is heating your pool.*

STEP 2: HEATING YOUR POOL

WARNING: If the panel is full of water and has been sitting in the sun without the pump running, the water can get very hot. Hot water can cause burns, so be sure that everyone is away from the pool inlet each time the solar is turned on.

When the solar system is running efficiently, the panel will be cool to the touch. The sun's heat will be carried into your pool immediately. For best results, turn on your Solar Bear whenever the panel is in the sun. Turn the solar and/or the pump off at night, when it's cloudy, or when it's raining to prevent cooling of the pool. If your pool system has a timer, set it to operate from 9 a.m. until 5 p.m. This is the best solar heating period.

Using a solar blanket in addition to the solar panel will hold the warmth in the pool and help it heat more quickly. It is particularly important to use the blanket at night or when it's windy.

If your pool becomes too warm during the season, turn the pump and solar on at night to help *cool* the pool.

COOL IS HOT !

When your solar panel is working properly it will feel cool to the touch. This is because the solar energy (heat) is carried away immediately into your pool.

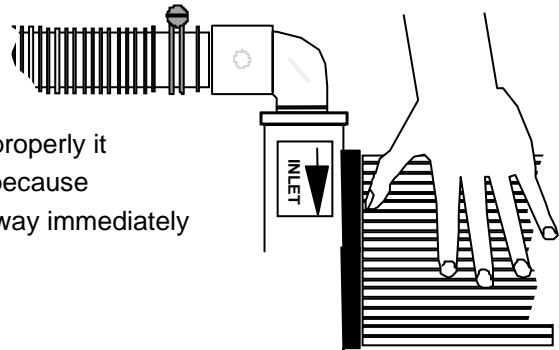

NOTE: To optimize solar system performance and pool water circulation FAFCO strongly recommends installing a manual by-pass valve. Contact the company you purchased your system from to obtain the valve. A by-pass valve should be installed with pumps larger than 1 Horse Power.

STEP 3: WINTERIZING

The panel must be drained and stored before the first frost. If water is allowed to freeze in the panel it may damage it. This damage is not covered by your warranty.

1. Turn off your pool pump.
2. Place the plugs given to you with your pool in the inlet and outlet of the pool.
3. Disconnect both the hoses from the hose barbs on the solar heater. Disconnect the hose that came with your solar system from the pool inlet. Connect the hose from the pump to the inlet on the pool.
4. Remove the plugs from the inlet and outlet of the pool and check the hose clamps you just tightened for leaks.
5. Unscrew the white drain plug that's located on the panel end opposite the inlet and outlet.
6. Roll the panel and secure using the carrying strap. Tilt panel until water no longer comes out. *Replace drain plug*, and store the panel and plumbing in the garage or a shed until next spring.

Some Suggested Mounting Ideas

Although it's not necessary to permanently mount your Solar Bear solar panel, we've included some ideas below to demonstrate how it may be done.

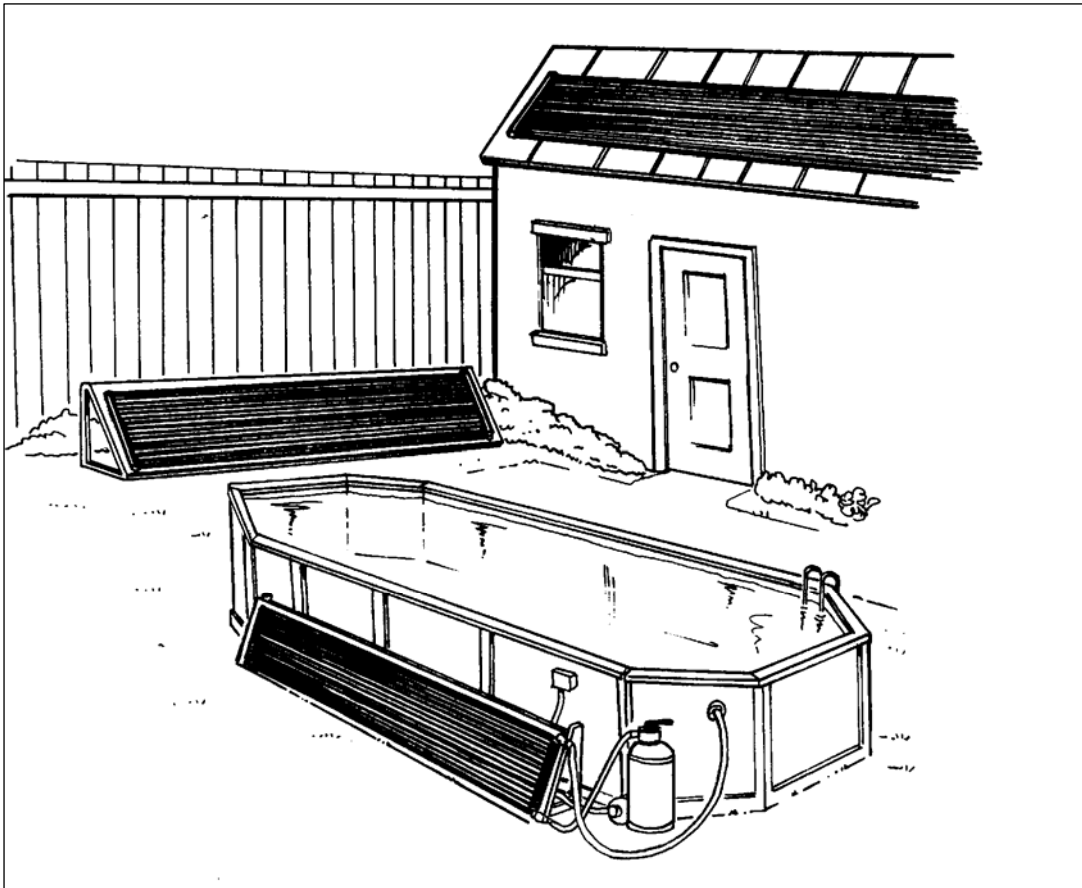

Repairing your Solar Bear System

If your solar panel develops a leak, you should contact the store where you purchased it for repair information.

For other repairs, see your warranty.

Some of the solar heating systems come with hoses. The hoses included in these systems can be replaced at any pool store. Cut a short length of the hose to take with you, so you'll be sure to get the correct size.

ABOVE GROUND POOL SOLAR TROUBLESHOOTING GUIDE

PROBLEM	SOLUTION
1. My system doesn't seem to be working.	Turn off pool pump midday in bright sunlight for approximately 10 minutes and feel solar panel. It should be quite warm. Turn pool pump on again for 10 minutes and feel the solar panel, which should have become quite cool to the touch. The difference in temperature is the heat being added to your swimming pool. (See problem 2 below.)
2. My pool is not warm enough.	<p>Start with problem #1 above to be sure your system is working correctly. The following can be done to optimize the performance of your system:</p> <ul style="list-style-type: none"> • Be sure the solar panel is getting sun the entire day and is not shaded. • If inclined on a rack, be sure the solar panel is pointed south or a little west of south. • Although less important, be sure the solar panel is inclined at approximately 30° to 45°. <p>NOTE: If panel is inclined, be sure the inlet side is on the bottom. The system will not function if fed from the top.</p> <p>If all of the above are accomplished, then consider adding an additional panel. (See problem 7 below.)</p>
3. The water returning to my pool is not hot.	<p>The solar panel works best when its surface temperature in direct sunlight is as low as possible. This indicates all of the solar energy is being drawn from the surface of the panel and conducted back into your pool. Therefore, the water returning from the solar panel should be only a few degrees warmer than the water going into it.</p> <p>NOTE: The Plus System includes a spring-loaded valve built into the solar panel. This valve is calibrated to optimize the performance of the solar by regulating the flow of water through the panel. It also protects your system from excess pressure that may otherwise damage your pump.</p> <p>If you have a high horsepower pump, a significant portion of that water will be bypassed, causing the return water to seem only slightly warmer than the pool water.</p>
4. There are bubbles in the pool during startup.	This is normal since during startup your pool water is purging the air in your solar panel.
5. Flow seems greatly reduced and the filter pressure excessive.	Check that the vinyl caps were removed from the inlet and outlet prior to installation. Also be sure the inlet and outlet have not been reversed.
6. Should I use a pool cover with my solar system?	The cover prevents evaporation loss, particularly at night. The cover traps the solar heat, which has been added during the day. This is very complementary to the solar system. The solar can be viewed as actively adding heat. The cover retains heat passively.
7. Can normal 8, 10, and 12 foot solar panels be used to heat my above ground pool?	Your Solar Bear Above Ground Pool System has been especially designed to heat your above ground pool most effectively. If your pool is particularly large or you wish to have even more solar heat, then ask the retailer who supplied your above ground pool heating system for details to add more solar panels.

FAFCO, Inc.
435 Otterson Drive
Chico, CA 95928
Phone: 800-994-7652
Fax: 530-332-2119

P/N 07188A 11/05